

Doctoral School of Engineering Sciences and Mathematics

Doctoral Panel: Industrial Engineering

DOCTORAL THESIS

IMPROVING THE PERFORMANCE OF CHIPPING PROCESSES USING CHIPPING TOOLS WITH OPTIMAL FUNCTIONAL GEOMETRY

-ABSTRACT-

PhD student:
Ing. Mădălin TOMESCU

Doctoral coordinator:
Prof. univ. dr. ing. habil. Dan DOBROTĂ

KEY WORDS

transverse feed turning, longitudinal feed turning, classic cutting tool, smart cutting tool, vibration, F.F.T. analysis method, S.T.F.T. analysis method, M.A.S.V. analysis method, finite element modeling, static analysis, modal analysis, harmonic analysis, roughness , filtered profiles, curve profiles, abbot-firestone curves, vibration diagrams, spectrograms, cutting forces, multiple regression analysis method

SUMMARY OF CONTENTS



THESIS CONTENTS	4
INTRODUCTION-IMPORTANCE OF THE STUDY	
CHAPTER 1 - THE CURRENT STAGE OF THE ANALYSIS OF VIBRATIONS THAT APPEAR IN CHIPPING PROCESSES	9
1.1 Analysis of the possibilities of measuring and reducing the vibrations occurring during the cutting process	9
1.2 Conclusions	11
1.3 The objectives of the doctoral thesis	13
CHAPTER 2 - MATERIALS, TOOLS AND METHODS USED WITHIN EXPERIMENTAL RESEARCH	15
2.1 Materials used experimental research	15
2.2 Tools used in the research	15
2.2.1 Presentation of tools used for applied research	15
2.3 Methods use in research	17
2.3.1 Analysis and measurement of vibrations that occur during machining processes	18
2.3.2 Analysis and measurement of the roughness of processed surfaces	20
2.3.3 Analysis and measurement of forces and power when turning parts	20
2.4 Conclusions	20
CHAPTER 3 - DETERMINATION OF THE TRAJECTURES OF THE TOP OF THE CHIPING TOOL THROUGH MATHEMATICAL MODELING	22
3.1 Introduction	22
3.2 Analysis of the tool tip trajectory	22
3.3 Conclusions	24
CHAPTER 4 - NUMERICAL SIMULATION USING THE FINITE ELEMENT METHOD OF THE OPERATION OF CUTTING TOOLS WITH OPTIMUM FUNCTIONAL GEOMETRY	26
4.2 Static analysis	27
4.3 Modal analysis	27
4.4 Harmonic analysis	29
4.5 Conclusion	29
CHAPTER 5 - PERFORMANCE ANALYSIS OF THE USE OF CUTTING TOOLS WITH OPTIMAL FUNCTIONAL GEOMETRY FROM THE POINT OF VIEW OF VIBRATION	31
5.1 Overview	31
5.2 Results obtained following research using cutting tools with optimal functional geometry for turning with transverse feed	31
5.2.1 Analysis of the experimental results obtained in the case of applying the analysis method of fast fourier transform (F.F.T.)	31

5.2.2	Analysis of the experimental results obtained in the case of applying the analysis method a short time Fourier transform (S.T.F.T.)	32
5.2.3	Analysis of the experimental results obtained in the case of applying the analysis method of the vibration signal (M.A.S.V.)	35
5.3	Performance analysis of cutting tools with functional geometry optimal from the point of view of vibrations in the case of longitudinal turning	38
5.3.1	Analysis of the experimental results obtained using the Fast Fourier Transform (F.F.T.) analysis method	38
5.3.2	Analysis of the experimental results obtained in the case of the application of the Short Time Fourier-Transformation S.T.F.T. (Short Time Fourier-Transformation) analysis method	39
5.3.3	Analysis of the experimental results obtained in the case of applying the analysis method of the vibration signal (M.A.S.V.)	40
5.4	Conclusions	41

CHAPTER 6 - PERFORMANCE ANALYSIS OF THE USE OF CUTTING TOOLS WITH OPTIMAL FUNCTIONAL GEOMETRY FROM THE POINT OF VIEW OF THE QUALITY OF THE SURFACES PROCESSED BY CUTTING 44

6.1	Overview	44
6.2	Results obtained as a result of machining research with transverse feed turning using cutting tools with optimal functional geometry	44
6.3	Performance analysis of the use of cutting tools with optimal functional geometry from the point of view of surface quality in the turning operation with longitudinal feed	49
6.4	Conclusions	50

CHAPTER 7 - PERFORMANCE ANALYSIS OF THE USE OF CUTTING TOOLS WITH OPTIMUM FUNCTIONAL GEOMETRY FROM THE POINT OF VIEW OF THE FORCES AND POWER CONSUMED FOR CUTTING 51

7.1	Overview	51
7.2	Performance analysis of the use of cutting tools with optimal functional geometry in terms of cutting forces in the case of turning with transverse feed	55
7.3	Performance analysis of the use of cutting tools with optimal functional geometry in terms of cutting forces in the case of turning with transverse feed	55
7.4	Conclusions	55

CHAPTER 8 - CONCLUSIONS, ORIGINAL CONTRIBUTIONS AND FUTURE RESEARCH DIRECTIONS 57

8.1	General conclusions of the doctoral thesis	57
8.2	Contributions in the field of theoretical and experimental research carried out within the research	59
8.3	Future research directions	62

REFERENCE 63

THESIS CONTENTS

INTRODUCTION - THE IMPORTANCE OF THE STUDY	1
CHAPTER 1 - THE CURRENT STAGE OF THE ANALYSIS OF VIBRATIONS THAT APPEAR IN CHIPPING PROCESSES	3
1.1 General notions	3
1.2 Types of vibrations encountered in machining processes	4
1.3 Types of errors introduced by the vibrations of the technological system during machining	10
1.4 Effects of vibrations on machining processes	12
1.5 Vibration analysis methods/techniques	17
1.6 Analysis of vibration reduction possibilities	18
1.7 Vibration reduction methods	22
1.8 Analysis of the possibilities of measuring and reducing the vibrations occurring during the cutting process	25
1.9 Systems for monitoring the active part of the cutting tool	29
1.10 Analysis of the influence of vibrations on the quality of parts processed by turning	35
1.11 Presentation of the research methodology for establishing the influence of vibrations on the roughness of processed surfaces	40
1.12 Conclusions	42
1.13 The need to create intelligent cutting tools from the perspective of PLM - Product life cycle management	44
1.13.1 Stages in product development	44
1.13.1.1 The classic approach to product development	44
1.13.1.2 The modern approach to product development	45
1.14 The objectives of the doctoral thesis	46
CHAPTER 2 - MATERIALS, TOOLS AND METHODS USED WITHIN EXPERIMENTAL RESEARCH	48
2.1 Introduction	48
2.2 Materials used in experimental research	50
2.2.1 Characterization of the steels used in the research	52
2.3 Tools used in research	53
2.3.1 Overview	53
2.3.2 Analysis of the evolution of the functional geometry of the cutting tool during the turning operation	54
2.3.2.1 Analysis of the evolution of the functional geometry of the cutting tool when turning with longitudinal feed	54

2.3.2.2	Analysis of the evolution of the functional geometry of the tool during feed turning transverse	56
2.3.3	Presentation of tools used for applied research	58
2.4	Methods used in research	60
2.4.1	Analysis and measurement of vibrations that occur during machining processes	64
2.4.2	Analysis and measurement of the roughness of processed surfaces	68
2.4.3	Analysis and measurement of forces and power when turning parts	69
2.5	Conclusions	71
CHAPTER 3 - DETERMINATION OF THE TRAJECTURES OF THE TOP OF THE CHIPING TOOL THROUGH MATHEMATICAL MODELING		73
3.1	Introduction	73
3.2	Elements of a dynamic nature that require the cutting tool	74
3.3	Systems for reducing the vibrations of the cutting tool	79
3.4	Analysis of the tool tip trajectory	82
3.4.1	Determination of cutting tool trajectories using Hilbert spaces	84
3.4.1.1	Convergence of trajectories	86
3.4.1.2	The situation in which the product $\alpha \cdot \gamma = 48$	86
3.4.1.3	The situation in which the product $\alpha \cdot \gamma < 48$	86
3.5	Conclusions	90
CHAPTER 4 - NUMERICAL SIMULATION USING THE FINITE ELEMENT METHOD OF THE OPERATION OF CUTTING TOOLS WITH OPTIMUM FUNCTIONAL GEOMETRY		92
4.1	General information on the finite element method	92
4.2	Static analysis	94
4.3	Modal analysis	99
4.4	Harmonic analysis	105
4.5	Conclusions	116
CHAPTER 5 - PERFORMANCE ANALYSIS OF THE USE OF CUTTING TOOLS WITH OPTIMAL FUNCTIONAL GEOMETRY FROM THE POINT OF VIEW OF VIBRATION		117
5.1	Overview	117
5.2	Results obtained following research using cutting tools with optimal functional geometry for turning with transverse feed	119
5.2.1	Analysis of the experimental results obtained in the case of applying the analysis method of fast fourier transform (F.F.T.)	119
5.2.2	Analysis of the experimental results obtained in the case of applying the analysis method a short time Fourier transform (S.T.F.T.)	132

5.2.3	Analysis of the experimental results obtained in the case of applying the analysis method of the vibration signal (M.A.S.V.)	145
5.2.4	Conclusions	158
5.3	Performance analysis of cutting tools with functional geometry optimal from the point of view of vibrations in the case of longitudinal turning	159
5.3.1	Analysis of the experimental results obtained using the Fast Fourier Transform (F.F.T.) analysis method	159
5.3.2	Analysis of the experimental results obtained in the case of the application of the Short Time Fourier-Transformation S.T.F.T. (Short Time Fourier-Transformation) analysis method	173
5.3.3	Analysis of the experimental results obtained in the case of applying the analysis method of the vibration signal (M.A.S.V.)	186
5.4	Conclusions	199
CHAPTER 6 - PERFORMANCE ANALYSIS OF THE USE OF CUTTING TOOLS WITH OPTIMAL FUNCTIONAL GEOMETRY FROM THE POINT OF VIEW OF THE QUALITY OF THE SURFACES PROCESSED BY CUTTING		202
6.1	Overview	202
6.2	Results obtained as a result of machining research with transverse feed turning using cutting tools with optimal functional geometry	203
6.3	Performance analysis of the use of cutting tools with optimal functional geometry from the point of view of surface quality in the turning operation with longitudinal feed	220
6.4	Conclusions	237
CHAPTER 7 - PERFORMANCE ANALYSIS OF THE USE OF CUTTING TOOLS WITH OPTIMAL FUNCTIONAL GEOMETRY FROM THE POINT OF VIEW OF THE FORCES AND POWER CONSUMED FOR CUTTING		239
7.1	Overview	239
7.2	Performance analysis of the use of cutting tools with optimal functional geometry in terms of cutting forces in the case of turning with transverse feed	239
7.3	Performance analysis of the use of cutting tools with optimal functional geometry in terms of cutting forces in the case of turning with transverse feed	250
7.4	Conclusions	261
CHAPTER 8 - CONCLUSIONS, ORIGINAL CONTRIBUTIONS AND FUTURE RESEARCH DIRECTIONS		262
8.1	General conclusions of the doctoral thesis	262
8.2	Contributions in the field of theoretical and experimental research carried out within the research	264
8.3	Future research directions	267
REFERENCE		268



THE IMPORTANCE OF THE STUDY

Due to the global requirements and challenges faced by the machining industry, in terms of productivity, quality and cost price issues, it is imperative to study the aspects regarding the optimization of machining technological processes composed of machine tool - device processing - cutting tool - part, as a whole.

Each component of the MUDSP system contributes, individually, but also cumulatively to meet the global requirements and challenges that the machining industry must keep up with.

The optimal choice of the specific parameters of the machining processes, as well as the choice of the corresponding MUDSP system, represent a viable solution in achieving the objectives regarding the results of the machining processes.

The optimal selection of cutting conditions effectively contributes to increasing productivity and quality, but also to reducing production costs, thus creating the conditions for sustainable production.

Optimizing the parameters that influence the chipping process is essential for a production unit to respond effectively to the severe competition and the increase in the demand for quality product in the market. In the cutting process, the optimization of cutting parameters is considered to be a vital tool for improving the production quality of a product as well as reducing the overall production time.

An optimization technique provides an optimal solution to a situation that needs improvement, which can be implemented in your own metal cutting process.

Quality and productivity play a major role in today's manufacturing market. From the customer's perspective, quality is very important, because the degree of quality determines their satisfaction. Apart from quality, there is another important criterion called productivity, which is directly related to the profits of an industry and its growth.

The chipping tool is a component part of the MUDSP system and has the role of creating the surfaces of the parts by removing the surplus material provided as a processing additive in the form of chips, thus the chipping tool contributes decisively to the optimal performance of the chipping processing processes, therefore it is necessary to use cutting tools with an optimal geometry during processing. The designed geometry of cutting tools refers to the constructive geometry, but during cutting operations the constructive geometry becomes a functional one. Thus, the functional geometry of the tools is the one that greatly influences the machining process of the parts and implies the quality of the obtained parts. Currently, special attention is paid to the constructive geometry of the cutting tool, without taking into account the fact that the functional geometry of the tool also depends on the following parameters: cutting speed, feed speed and dimensions of the processed piece. It should be mentioned that, due to the chipping process being carried out with tools with improper geometry, additional dynamic phenomena (vibrations) appear, generating negative effects on the results obtained.

On the basis of what was mentioned in the research, it is aimed to identify and test the possibilities of maintaining the optimal functional geometry and at the same time allowing the control of vibrations that appear in the machining process by chipping according to the

machining conditions in order to improve the quality of the obtained surfaces and reduce the forces and power required carrying out the cutting process.

In the framework of the applied research activity, the main objective is the identification and testing of some solutions regarding the identification of elastic elements that, mounted on the cutting tool, will allow to preserve the optimal geometric parameters, but also to combat the dynamic phenomena (vibrations) that appear during the cutting process, so that the chipping process respects the mentioned principles, in the context of a sustainable production, respecting the three pillars: environmental, economic and social .

According to what was presented, the research will be based on finding technical solutions by creating intelligent cutting tools in order to maintain an optimal functional geometry, in order to reduce/eliminate the dynamic phenomena represented by vibrations.

In this sense, the research focuses on turning operations with transverse and longitudinal feed, for materials widely used in the machine building industry (C45, 42CrMo4 respectively S235), using the variants of smart cutting tools created (those cutting tools that have in their composition elements elastic), but also the cutting tool in the classic version (without elastic elements in the composition) in order to compare the results obtained from the point of view of the vibration amplitude, the roughness of the processed surfaces and the necessary cutting forces.

In this way, the turning processing process will respect the basic principles in order to achieve a sustainable production.

CHAPTER 1



THE CURRENT STAGE OF THE ANALYSIS OF VIBRATIONS THAT APPEAR IN CHIPPING PROCESSES

1.1. Analysis of the possibilities of measuring and reducing the vibrations occurring during the cutting process

Vibration issues are of great interest in turning operations. The vibrations that occur during machining operations have a negative impact on the quality of the surfaces obtained.

Based on this consideration, a project of active vibration control in external longitudinal turning operations was initiated in 1997 by the Department of Mechanical Engineering, Lund Institute of Technology, LTH.

A working solution was developed where vibrations were reduced by about 40 dB and resulted in a PhD thesis for Lars Hakansson. A schematic of the first test model developed at the Department of Mechanical Engineering, Lund Institute of Technology, LTH is shown in Figure 1.1. The following figures show several constructive options for reducing vibrations during cutting.

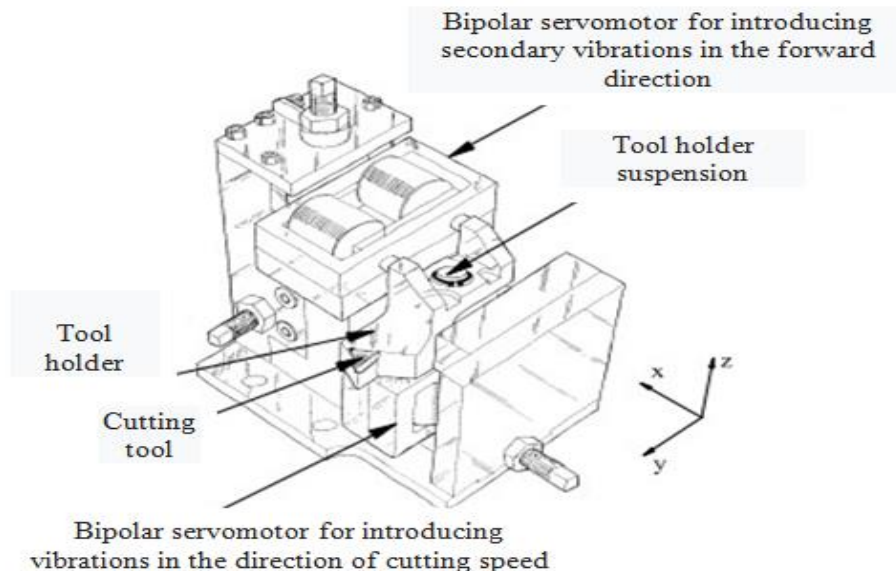

Figure 1.1. The first working model developed at LTH for vibration damping [56]



Figure 1.2. First attempt at an active tool support solution using the technique piezo - ceramic for vibration attenuation [56]



Figure 1.3. The solution made by piezotronic PCBs of the active instrument using a piezo-ceramic attenuator [56]

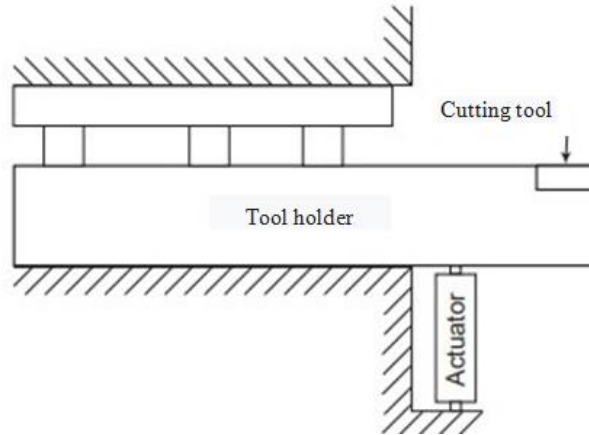

Figure 1.4 . The first solution developed at BTH for dampening vibrations using a piezo ceramic actuator mounted outside the tool holder [56]

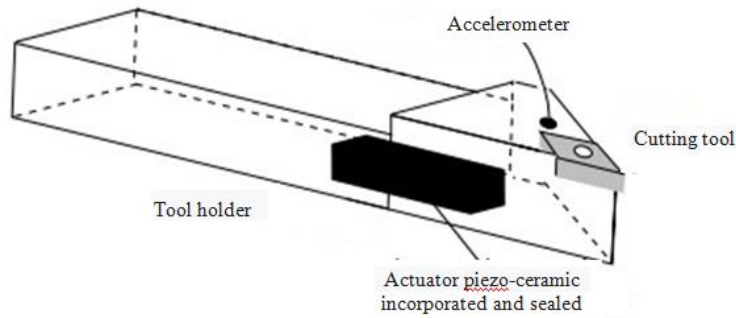

Figure 1.5. Standard tool body with a built-in piezo-ceramic actuator [56]



Figure 1.6 . Active tool holder called ActiCut™ with a built-in piezo-ceramic, attenuator and accelerometer [56]

1.2. Conclusions

- cutting processes are currently the most important method of generating the surfaces of the parts used in the machine building industry, so among all the processing methods, the most used method is the machining process, which accounts for about 70% of the total parts used in the industry, as a result this the process is quite important in terms of the development of the car manufacturing industry ;
- the mechanical machining processes by cutting are quite complex because for the generation of surfaces, the technological machine-tool-device-tool-part (MUSDP) system represents a predominantly elastic system; that 's why, during the development of mechanical machining processes by cutting, inevitable dynamic phenomena appear, phenomena that have a negative impact on their performance , dynamic phenomena being inevitable and difficult to control, generating unwanted effects such as: affecting the quality of the surfaces obtained by cutting, reducing the production capacity of the technological system used, rapid and premature wear of the machine tools used, of the cutting tools and not only, generate additional costs for combating and reducing dynamic phenomena, generate additional consumption, etc. ;
- carrying out the monitoring of the dynamic phenomena that accompany the processing processes through chipping can be achieved by using complex techniques for measuring or estimating various physical quantities specific to the chip formation process, but also to characterize the state of rigidity of the technological system used ;
- the dynamic phenomena within the machining processes are born due to the interaction between the MUDSP system and the work processes that accompany the operation of machine tools, because the whole assembly is subjected to forces with different intensities and frequencies ;
- the dynamics of machines - tools represented and represents an important problem of interest, due to its significant role in the stability and results of machining processes, and has a large impact on the stability of the machining process;
- in a turning process, three different types of mechanical vibrations are present from the cause of the lack of stiffness/dynamic stiffness of the machine tool system comprising the tool, the tool holder, the workpiece and the machine tool itself; these types of vibrations are: free vibrations, forced vibrations, self-excited vibrations (chatter);
- in order to eliminate/reduce the negative effects of free and forced vibrations is it is necessary to identify the sources generating vibrations, and self-vibrations are not yet fully understood due to its complex nature, therefore they are explained on the basis of several theories/hypotheses; these theories/hypotheses are: Taylor's Hypothesis, Kaşirin's Theory, Sokolocvsky's Theory, Harnis and Grig's Theory, Toblas' Theory;
- the need to develop better techniques to reduce and control vibrations more and more strongest due to pressure on manufacturing industries for high productivity, high precision, low scrap and lower production costs; vibration reduction and control techniques can be classified into two main categories, namely: passive vibration reduction/control, active vibration reduction/control;

Passive damping is based on a damping structure / damped cutting tools or by using special clamping devices.

Active damping uses online data recorded during the machining operation and adjusts it to create anti-resonance. Active damping can be used for a number of different frequencies over a wide tuning range. The best way to reduce forced vibrations is to reduce/eliminate disturbing factors. The reduction/decrease of vibrations is influenced by the rigidity of the technological system and can be achieved by increasing the rigidity of the technological system. The overall analysis of the realization and development of the technological processes of mechanical processing by turning highlighted the fact that the lack of rigidity of the technological system accentuates the dominance of the performances of the turning processing processes.

- in the turning process due to the wide variety of factors that participate in its development, it is difficult to identify their individual or cumulative influence on the optimal development of the machining processes; moreover, the influence of transition factors (wear of the cutting tool, thermal phenomena located in the cutting area), is very difficult to quantify in terms of the cumulative impact on the results of the cutting processing processes. The contact zone between the cutting tool and the piece, represents the most sensitive area to the action of the lack of rigidity of the technological system and the dynamic factors that appear during the realization of the mechanical processing by chipping. The study of the vibrations that appear during the machining processes by chipping Machining has been a research topic since the early stages of the development of machining processes.
- this phenomenon of vibrations is indispensable within the processing by cutting, having a negative impact on the results obtained by the chipping processing processes as well as on the physical integrity of the MUDSP system.
- the analyzed research aimed to identify the sources generating vibrations, the types of vibrations, the methods of their analysis and reduction and implicitly the analysis of their impact on the quality of the processed surfaces, on the cutting tool, on the influence of the cutting forces because they influence the cutting power and implicitly the consumptions necessary to carry out the technological process of processing by cutting. Thus, the studies carried out over time have highlighted the fact that the lack of rigidity of the technological system leads to an increase in vibrations and processing errors.
- vibrations in the cutting process occur due to the interaction of all elements components necessary to carry out the cutting process (machine tool-tool-semi-finished product), for which technical solutions were sought to reduce/eliminate them from the cutting process, thus a working solution was developed in which vibrations were reduced by approximately 40 dB and led to a PhD thesis for Lars Hakansson. The magnetostrictive model was not suitable for industrial purposes, however, so further improvements were needed.
- based on the analysis of the current state of scientific and technical research in the field, sa highlighted the fact that the study of the influence of low rigidity and the appearance of vibrations in the technological system have an effect on the precision of turning processing through the appearance of processing errors.
- machining precision is influenced by a multitude of factors, these factors are divided into two large categories: factors dependent on the cutting regime (cutting regime parameters, cutting force, self-vibrations, wear of cutting tools, thermal deformations of the cutting tool) and factors independent of the cutting regime (fixing and orientation of the part in the device, internal stresses of the semi-finished material,

forced vibrations, irregularities of the semi-finished parts by varying the cutting depth, etc.).

- the vibrations that occur during the machining process by chipping have as the main cause, the cutting force, generates negative effects on the quality of the finished product, thus, there is a link between the stability of the technological processing process and the quality of the products obtained. It is very important to develop solutions so that the vibrations accompanying machining processes can be controlled and reduced so that the effects they produce on the machining process as a whole can be reduced.

1.3. The objectives of the doctoral thesis

The need for the research carried out in the framework of the realization of this doctoral thesis started from the fact that the machining process is widely used in the machine building industry, thus starting from the premise that *the modern development of the machining industry* is based on the following principles such as: manufacturing flexibility (referring to the machine tool-tool), the quality of the surfaces obtained and the manufacturing cost price (which must be as low as possible), and in order to be able to satisfy these principles, in a decisive way the cutting tool also contributes, therefore it is necessary to use cutting tools with an optimal geometry during processing. The designed geometry of cutting tools refers to the constructive geometry, but during cutting operations the constructive geometry becomes a functional one. Thus, the functional geometry of the tools is the one that greatly influences the machining process of the parts and implies the quality of the obtained parts. Currently, special attention is paid to the constructive geometry of the cutting tool, without taking into account the fact that the functional geometry of the tool also depends on the following parameters: cutting speed, feed speed and dimensions of the processed piece . It should be mentioned that, due to the cutting process being carried out with tools with improper geometry, additional dynamic phenomena (vibrations) appear, generating negative effects on the results obtained.

On the basis of the mentioned, in the framework of the conducted research, it was aimed to identify and test the possibilities of maintaining the optimal functional geometry and, at the same time, allowing the control of vibrations that appear in the machining process by chipping according to the processing conditions in order to improve the quality of the obtained surfaces and reducing the forces and power required to carry out the cutting process. As part of the applied research activity, an elastic element model was identified and tested, which, mounted on the specially created cutting tool, allows to preserve the optimal geometric parameters, but also to combat the dynamic phenomena (vibrations) that occur during the cutting process, so that the process of chipping to respect the mentioned principles, in the context of a sustainable production, respecting the three pillars: environment, economic and social . Thus , referring to the mentioned and following the analysis of bibliographic sources and research in the field , we established the objectives of the doctoral thesis, as follows:

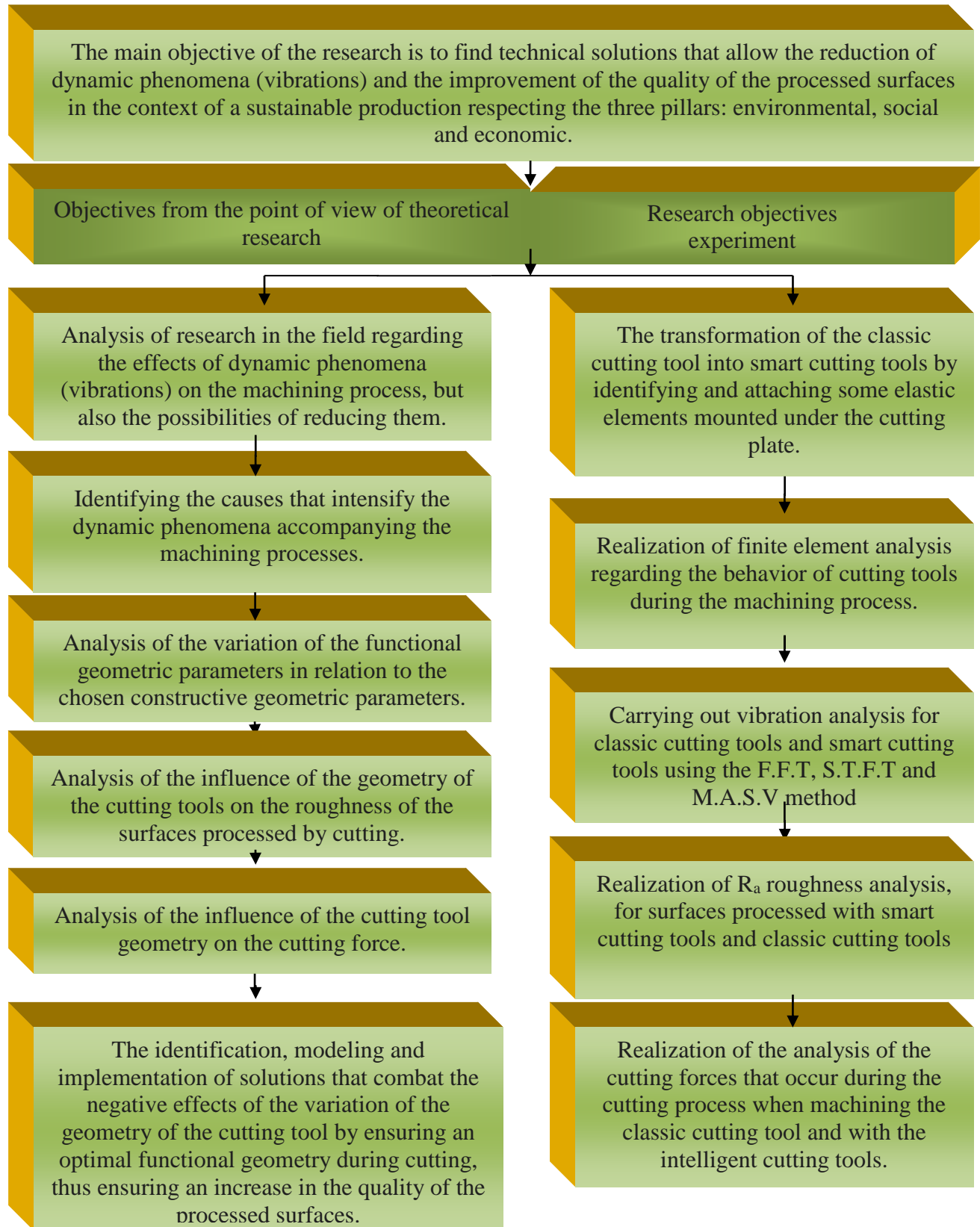

CHAPTER 2



MATERIALS, TOOLS AND METHODS USED WITHIN EXPERIMENTAL RESEARCH

2.1. Materials used in experimental research

Table 2.1. The materials used in the research and the cutting process parameters used in the research

No. No.	Materials used in carrying out research	Diameter, D [mm]	Cutting, speed V_a [m/min]	Advance, f [mm/rot]	Cutting depth, a_p [mm]
TURNING WITH TRANSVERSE FEED.					
1.	Steel C45 (1.0503): EN 10277-2-2008 ,	Ø 150	[90-110]	[0.2-0.36]	[0.9-3.6]
2.	Alloy steel 42CrMo4 - EN 10083-3	Ø 150	[70-100]	[0.2-0.36]	[0.9-3.6]
3.	Rolled steel S235- EN 10025-2	Ø 150	[90-120]	[0.2-0.36]	[0.9-3.6]
TURNING WITH LONGITUDINAL FEED					
4.	Steel C45 (1.0503): EN 10277-2-2008 ,	Ø 50	[120-150]	[0.2-0.36]	[0.9-3.6]
5.	Alloy steel 42CrMo4 - EN 10083-3	Ø 50	[90-140]	[0.2-0.36]	[0.9-3.6]
6.	Rolled steel S235- EN 10025-2	Ø 50	[160-210]	[0.2-0.36]	[0.9-3.6]

2.2. Tools used in the research

2.2.1. Presentation of tools used for applied research

To carry out the experimental research, a technological equipment of the type of a normal SN 400 lathe equipped with numerical control was used. The machining process was carried out using a turning knife. Thus, as part of the research, the elastic system was also tested on a SCLCL 2525 M12 cutting tool body assembly, used together with a metal carbide insert of the DCMT11T308EN-SM CTC 2135 type

The knife assembly thus obtained is characterized by the fact that it has a constructive geometry characterized by a release angle $\gamma=8^{\circ}$, an angle of placement $\alpha=6^{\circ}$ respectively a main attack angle $\chi_r=95^{\circ}$, the angle of inclination of the edge of the knife $\lambda=8^{\circ}$.

process is quite complex, especially in the case of parts made from materials with high physical-mechanical properties, but also by the functional geometry of the tools that change during processing. Thus, during machining, changes may occur in terms of the functional angles of the cutting tool with influences on the conditions in which the machining processes are carried out.

By creating these variants of cutting tools (T02, T03) we aimed to create an intelligent tool that has an optimal functional geometry.

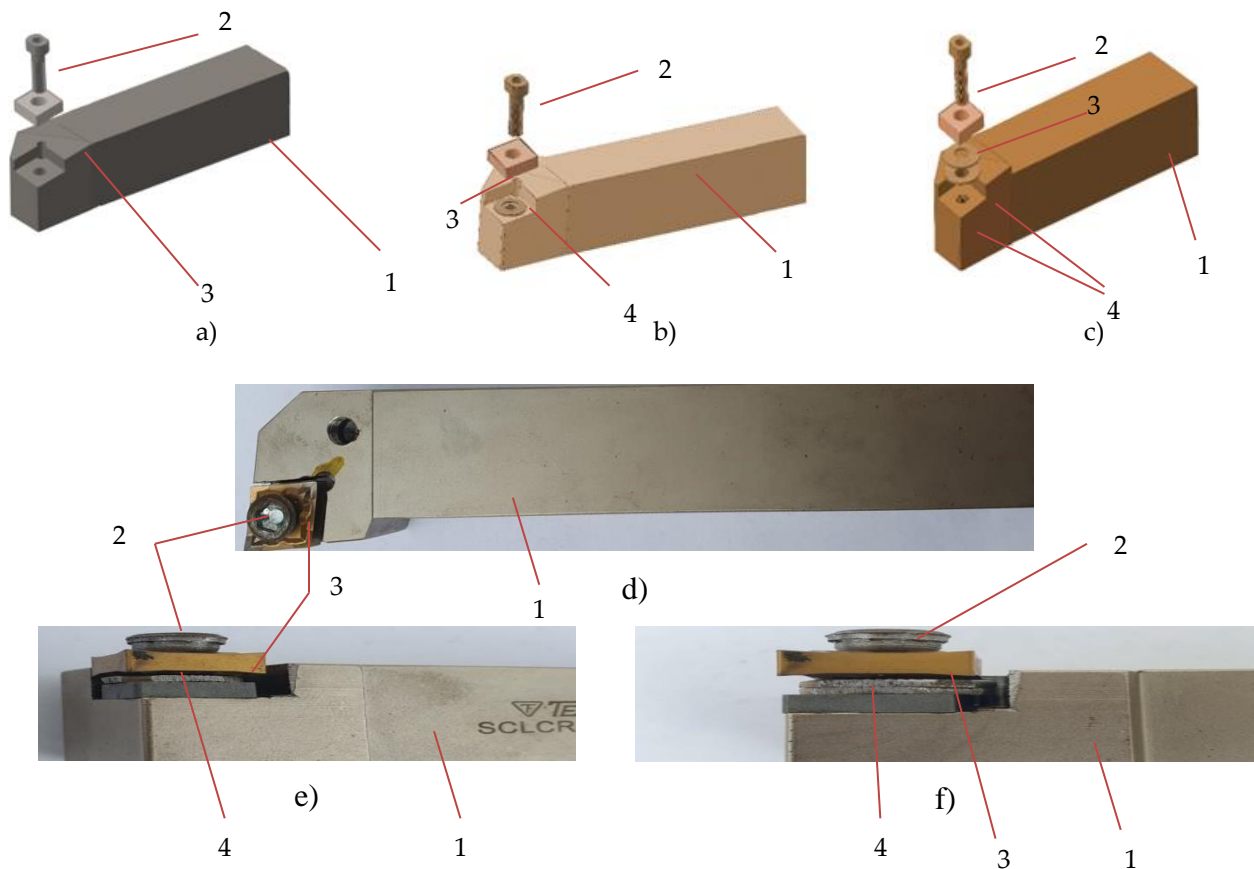

Figure 2.1. Cutting tools for turning used in research:

- a, d - in the classic version (T01); b, e—with improved constructive form with an elastic washer (T02); c, f – with improved constructive form with two elastic washers (T03);
- 1-knife body; 2-fixing screw; 3-removable plate; 4 – elastic washer
- d-special cutting tool used during research

As for the spring washer, this is a spring-disc washer, Figure 2.2, conforming to DIN 2093 B, steel A2 1.4305, and manufactured by Vinsco Spring Limited, Changzhou, China, it has been further machined by chipping, Figure 2.2 a, so as to ensure an optimal value of the elastic system created on the entire active part of the cutting tool.

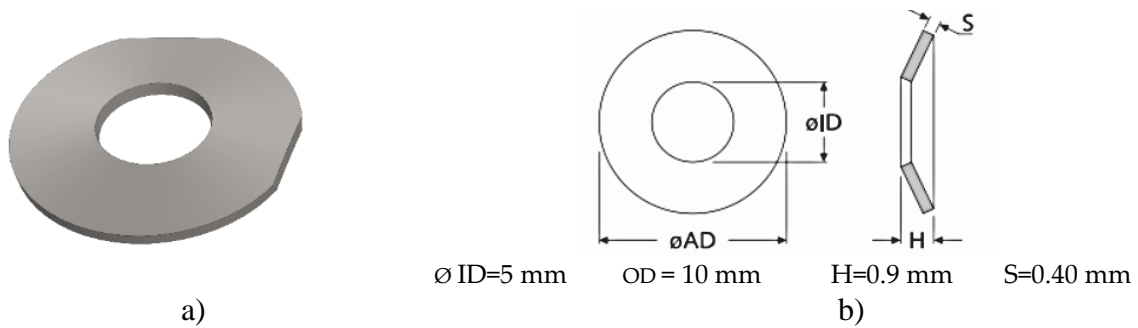

Figure 2.2. spring-disc elastic washer, DIN 2093 B:

a – image for the processed elastic washer; b – dimensional elements for the elastic washer

2.3 . Methods used in research

Multifactorial experiments are designed to assess multiple factors set at multiple levels. Experiments that use two or more controlled variables, also called factors of variation, represent factorial designs.

The factorial plans are not only aimed at the influence of each variation factor on the dependent variable, but they aim to determine the influence of the interaction of the variation factors on the output (dependent) variable. They comprise two groups obtained by randomization:

- ✓ the experimental group is the group to which the intervention is applied;
- ✓ the control (or control) group is the group that does not receive the intervention.

Table 2.2. The design of factorial experiments used to carry out the research

No. Ex.	The values of the input variables (independent) The parameters of the cutting regime						The value of the measured output variable [m/s ²],[μm],[daN];		
	Cutting depth a_p [mm]		advance [mm/rot]		Cutting speed [m/min]		The result (output variable), The amplitude of the vibrations, Roughness Ra, cutting force,		
	-1	+1	-1	+1	-1	+1	Tool T01	Tool T02	Tool T03
1	x		x		x				
2	x		x			x			
3	x			x	x				
4	x			x		x			
5		x		x		x			
6		x		x	x				
7		x	x			x			
8		x	x		x				
The average value of the output variable									

2.3.1. Analysis and measurement of vibrations that occur during machining processes

The main objective of the research was to ensure constant effective geometric parameters for the cutting tool to reduce self-vibrations explained by Sokolovsky's theory and Kaşirin's theory respectively.

Thus, the vibrations that accompany the machining process by chipping were measured in two main directions Z and Y respectively. In this sense, the vibration measurement system presented in Figure 2.3 was used.

Vibrations were measured in three distinct variants, namely:

- ✓ rigid fixation of the removable plate on the body of the knife;
- ✓ elastic fixing, which involves placing an elastic washer between the removable plate and the body of the tool, which allows obtaining constant effective geometric parameters for the cutting tool;
- ✓ the elastic fixation which involves placing two elastic washers between the removable plate and the body of the tool.

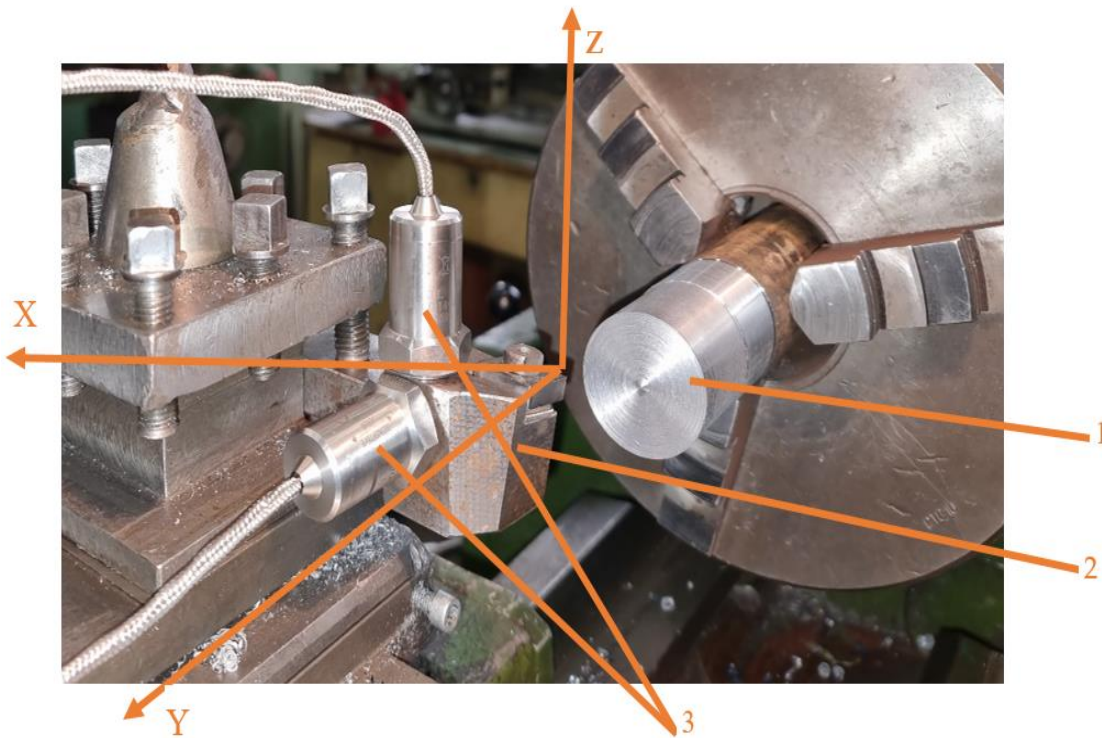

Figure 2.3. Scheme of the vibration measurement system:
1 - workpiece; 2 - the tool; 3 – accelerometers for measurement vibrations in the Y and Z directions respectively

An acquisition tool, presented in Figure 2.4, was designed to capture and process the vibrations that accompany the machining process by chipping.

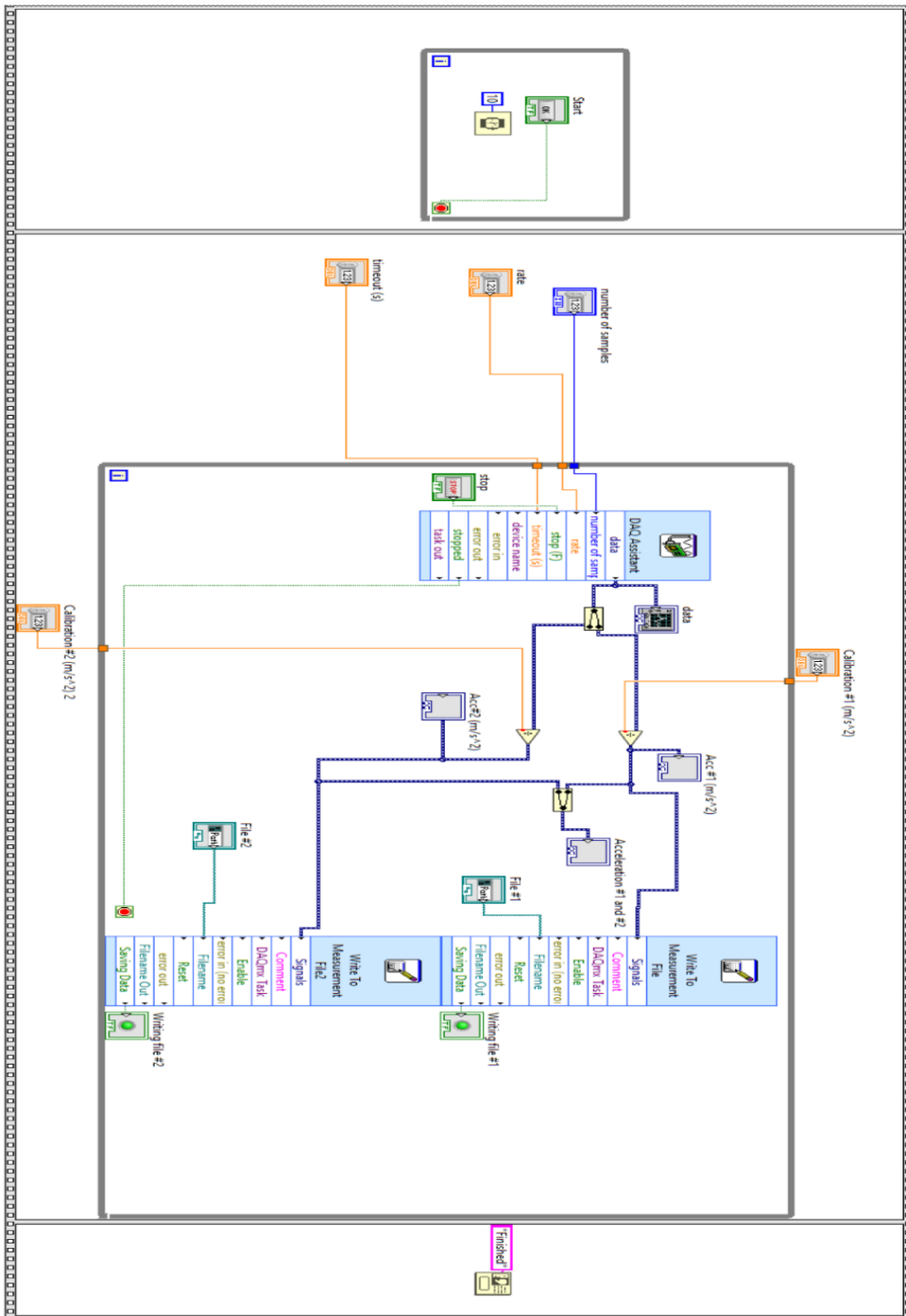

Figure 2.4. Vibration acquisition and processing tool

2.3.2 . Analysis and measurement of the roughness of processed surfaces

Hoffmann Industrial Tools SRL, Bucharest, Romania, was used to measure the roughness of the turned surfaces .

Also, the processing of the obtained results was carried out using the statistical software MINITAB.

2.3.3. Analysis and measurement of forces and power when turning parts

The system shown in Figure 2.9 was used in the research for monitoring the cutting forces, which allows the determination of the cutting forces in the 3 directions.

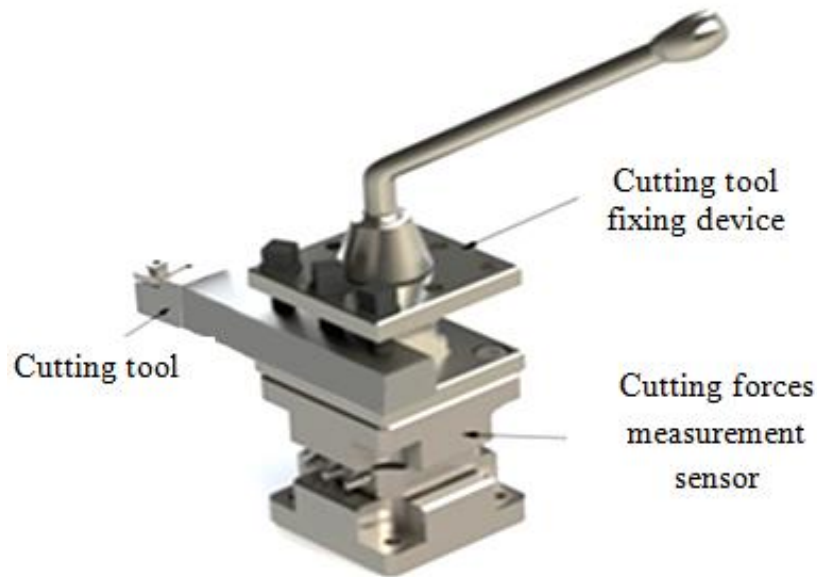

Figure 2.5. The system used to measure cutting forces

2.5. Conclusions

As a result of the analyzes carried out, it was found that the interaction of the MUSDP system influences the results of the turning processing process, influences the quality of the surfaces obtained following the chipping processing processes, and this represented a major interest from the beginning of the research on the factors that influence the quality of the processed surfaces by chipping.

- The machine building industry uses a varied range of metallic materials, materials that behave differently during machining due to the mechanical properties that characterize them;
- the research will aim to identify the influence of the geometry of the cutting tool on some response variables such as: the vibrations that appear in the machining processes by cutting; roughness of the machined surface and cutting forces;
- vibrations in the machining process occur due to the interaction of all the component elements of the technological system used in the machining process (machine tool, cutting tool, semi-finished product);

- in terms of machining processes, dynamic phenomena, more precisely vibrations, are generated in most cases by the variations in the force value resulting from the mechanical machining process. They transmit through the machine-tool-devices-cutting tool assembly negative effects on the quality of the workpiece, having as a consequence, uncontrollable values of the quality parameters of the processed surfaces;
- the overall analysis carried out creates a clear vision on the factors that influence the smooth development of the machining process by cutting and thus the carried out analysis demonstrated the imprint that the variation of the functional geometry leaves on the performances of the cutting process;
- the analysis carried out demonstrated the fact that the variation of the geometry of the cutting tools influences the dynamic phenomena that accompany the cutting process and influences the quality of the surfaces obtained by cutting and , consequently , within the research , it was aimed to identify some solutions to reduce the negative effects on the results of the processing process by cutting of the dynamic phenomena that accompany the processing process;
- analysis of the results obtained, following the use of intelligent cutting tools, with the help of specialized programs specific to experimental research.

CHAPTER 3

DETERMINATION OF THE TRAJECTURES OF THE TOP OF THE CHIPING TOOL THROUGH MATHEMATICAL MODELING

3.1. Introduction

Dynamical systems are often used to model and understand processes or phenomena that evolve over time and are used in various fields such as mathematics, physics, engineering, economics, biology, and many others. They can usually be described by differential equations or mathematical analysis methods to predict or control their future behavior.

A simple example of a dynamical system would be a pendulum, where the position and velocity of the pendulum varies with time under the influence of gravity and other factors. This is a dynamic system because its state (the angle and speed of the pendulum) is constantly changing depending on the initial conditions and the factors acting on it.

3.2. Analysis of the tool tip trajectory

Thus, the results obtained from the mathematical modeling with the help of Hilbert spaces were processed with the help of the Matlab program and the trajectories made by the classic cutting tool T01 and the intelligent cutting tools T02 and T03 were obtained.

Due to the presence of shock absorbers placed in the construction of smart cutting tools, the product between the angle of placement α (6°) and the angle of clearance γ (8°) is kept constant, i.e. $\alpha \cdot \gamma = 48$. While processing with the classic cutting tool the product $\alpha \cdot \gamma < 48$. Thus, Figure 3.1 shows the trajectory made by the classic cutting tool when turning with transverse feed, and Figure 3.2 shows the trajectory made by the intelligent cutting tool when turning with transverse feed. Also, Figure 3.3 and Figure 3.4 show the trajectories made by the classic cutting tool and the intelligent cutting tool respectively when turning with longitudinal feed.

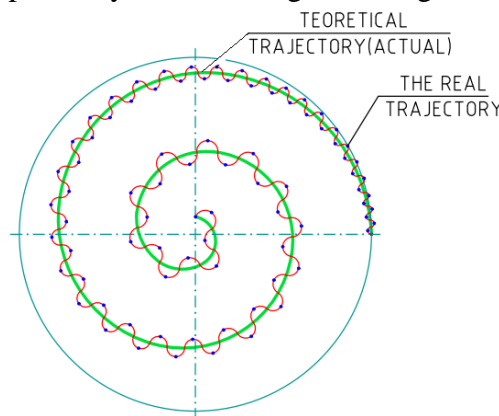

Figure 3.1. The trajectory made by the classic cutting tool for the generation of surfaces by turning with transverse feed

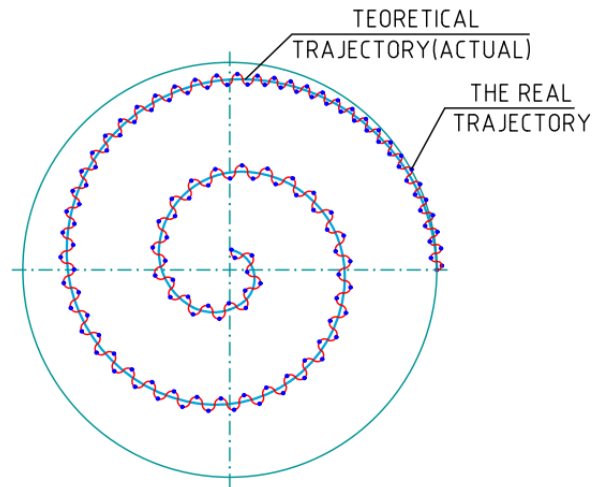

Figure 3.2. The path made by the intelligent cutting tool for the generation of surfaces by turning with transverse feed

From the analysis of Figure 3.1 and Figure 3.2, it emerges that both in the case of using the classic cutting tool and in the case of using the intelligent cutting tool, the real trajectory differs from the theoretical (ideal) trajectory. It is also observed that the trochoids produced by the vibrations in the case of the classic cutting tool at the beginning of the processing show lower values compared to the smart cutting tool, but they increase significantly once the machining process is carried out for the classic cutting tool compared to the smart cutting tool, reaching maximum values as the tip of the tool approaches the center of the piece for both cutting tools used (classic tool and smart tool). As for the trochoids, they increase greatly as the tip of the tool approaches the center of the part for processing with the classic cutting tool, while in the case of the smart cutting tool, they remain within approximately constant limits, achieving a slight increase with advancing the tip of the cutting tool towards the center of the part.

Figure 3.3 and Figure 3.4 respectively show the trajectories for turning with longitudinal feed with the classic cutting tool and the intelligent cutting tool.

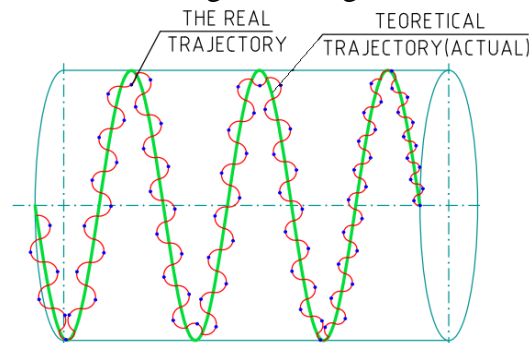

Figure 3.3. The trajectory made by the classic cutting tool for the generation of surfaces by turning with longitudinal feed

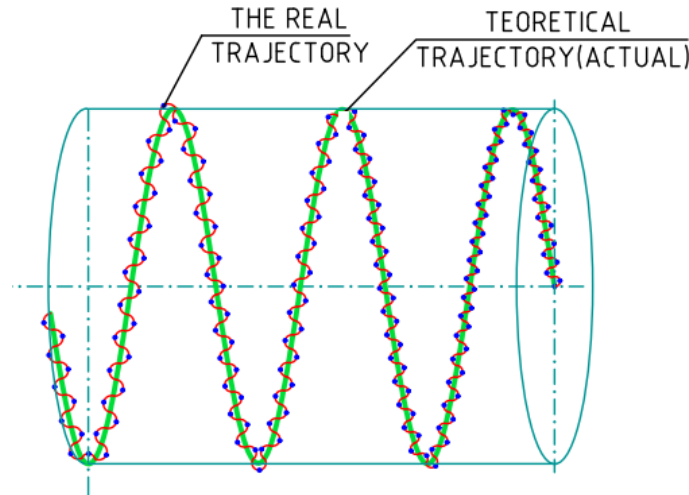

Figure 3.13. The path made by the intelligent cutting tool for the generation of surfaces by turning with longitudinal feed

According to Figure 3.12, when turning with longitudinal feed, with the classic cutting tool, it results that the vibration trochoids at the entry of the tool into the cutting show the lowest values, they increase with the advance of the tool into the cutting. Making the comparison with Figure 3.4, it can be seen that in terms of processing with the smart cutting tool, the vibration trochoids show higher values when the tool enters cutting compared to the classic cutting tool, but with the advance of the cutting tool they increase, but in smaller limits compared to those obtained by the classic cutting tool.

3.3. Conclusions

Analyzing the aspects presented in this chapter, we can draw the following conclusions:

- a dynamic system is an entity or system that evolves or changes over time ;
- elements of a dynamic nature refer to objects, processes or phenomena that are characterized by changes over time and that can be analyzed, using concepts and theories from the field of dynamic systems ;
- cutting tools are considered dynamic systems in the context of material processing because they involve interactions and changes over time, and in the case of cutting tools, this refers to the movement and interaction between the tool and the material being processed ;
- in order to generate the surfaces, the cutting tools make certain trajectories due to the movements they make ;
- it is important to note that the application of Hilbert spaces to determine the trajectories of dynamical systems can be very complex and largely depends on the specific nature of the system and the mathematical methods used ; for practical systems, approximations and numerical methods may be necessary to obtain valid solutions;

- the vibration trochoids increase greatly towards the center of the piece in cross-feed turning with respect to machining with the classic cutting tool compared to the smart cutting tool ;
- when entering the cutting, the vibration trochoids show higher values in the case of processing with the intelligent cutting tool compared to the classic cutting tool, with the classic cutting tool their increase is much higher and increases with the approach to the center of the part, while in the processing with the smart cutting tool, they grow in much smaller limits and tend to remain constant ;
- in terms of processing by turning with longitudinal feed, the evolution of vibration trochoids is within much lower limits than in terms of turning with transverse feed, their behavior for processing with the two categories of tools being similar to the case of processing by turning with transverse feed ;
- thus it is demonstrated that the amplitude of the vibration trochoids obtained by the intelligent tools is lower than when using the classic cutting tool, because due to the elastic elements in their composition, the vibrations are reduced, the functional geometry is kept within optimal limits, respectively the deposits on the cutting edge are reduced ;
- the large amplitude of the vibration trochoids obtained when using classic cutting tools causes an increase in the roughness of the processed surfaces, and the variation of the amplitude of the vibration trochoids during the cutting process causes an uneven surface to be obtained ;
- according to the obtained results, it follows that the intelligent cutting tools obtain superior performances in terms of the amplitude of the vibration trochoids, a fact that translates into the obtaining by the intelligent cutting tools of surfaces with lower roughness than in the case of classic cutting tools and at the same time the surface is more uniform due to the lower fluctuation of the vibration amplitude during the machining process ;

CHAPTER 4



NUMERICAL SIMULATION USING THE FINITE ELEMENT METHOD OF THE OPERATION OF CUTTING TOOLS WITH OPTIMUM FUNCTIONAL GEOMETRY

4.1. Static analysis

In the case of static analysis, the loads and constraints are independent of time. For each of the 3 tool models, the classic tool T01 and the two optimized tools, T02 and T03, we made the geometric models, as shown in figure 2.3.

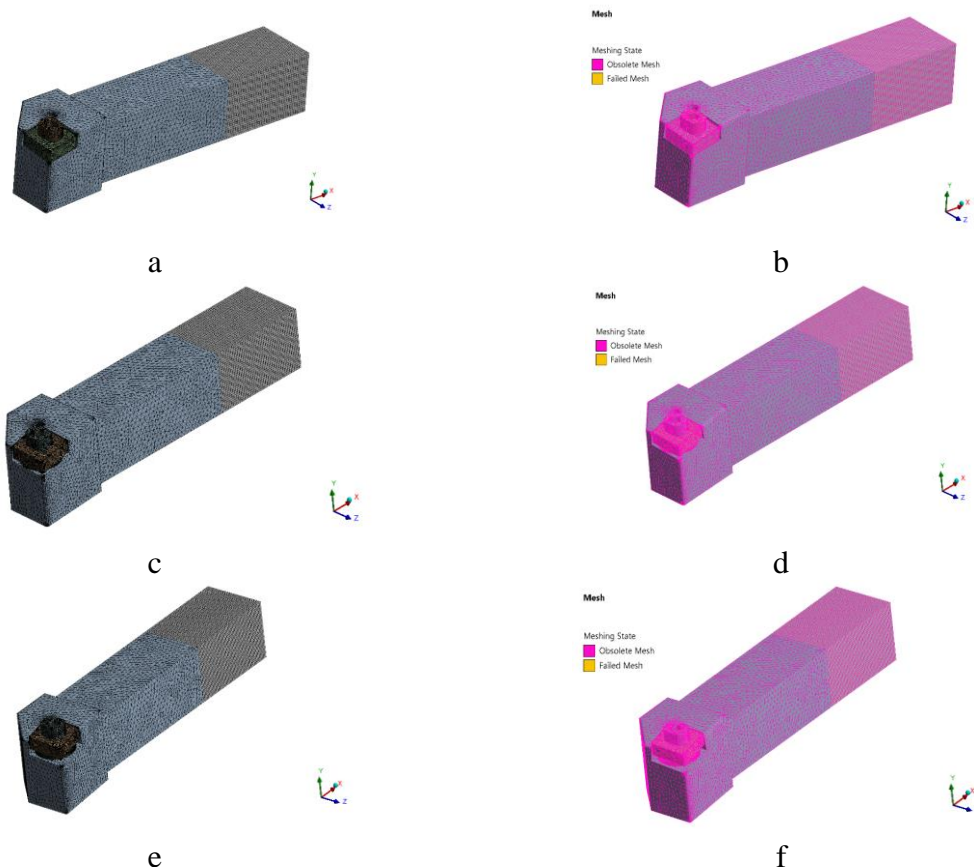

Figure 4.1. The finite element mesh used in both static and modal and harmonic analyzes and its quality: a – the mesh of finite elements for the cutting tool T01; b – the quality of the mesh of finite elements for the T01 cutting tool; c – the mesh of finite elements for the T02 cutting tool; d – the quality of the mesh of finite elements for the cutting tool T02; e – the mesh of finite elements for the cutting tool T03; f – finite element mesh quality for the T03 chipper

As can be seen from the figures above, the constraints were applied by canceling all degrees of freedom on the knife grip area in the knife holder, and the applied loads were the maximum loads measured during the machining process for the alloy steel. We chose these loads because they are the maximum loads resulting from the chipping process. These are presented in table 7.9. The clamping screws of the pads were prestressed with a load of 30N.

The results were focused on the determination of the equivalent Von Mises stress, the total resulting displacement and the directional displacements on the X, Y and Z axes.

Table 4.1 shows the results of the static analysis for the 3 types of tools.

Table 4.1. The results obtained for the static analysis for the three types of tools in the case of request for machining by turning with transverse feed of the material 42CrMo4-EN 10083-3- II 150mm.

No. crt.	Result type	Tool T01	Tool T02	Tool T03
1.	Von Mises equivalent stress [MPa]	295.28	288.91	282
2.	Total nodal displacement [mm]	0.0217	0.0354	0.0391
3.	Y-direction displacement[mm]	0.0026	0.0068	0.0089
4.	Travel in Z direction [mm]	0.0164	0.0269	0.0298
5.	Movement in the X direction [mm]	0.0022	0.0035	0.0028

As can be seen from the results presented in table 4.1, the maximum load present in the case of the classic tool, T01 leads to the highest value of the equivalent stress (295.28 MPa) but it is located at the level of the insert. There is no danger from this point of view because sintered metal carbide inserts withstand stresses of the order of GPa, depending on the type of insert. However, in the case of nodal displacements, in the case of a hypothetical static stress, the maximum nodal displacement occurs in the case of tool T03 – 0.0298 mm, followed by tool T02 – 0.0269 mm, respectively tool T01 – 0.0164 mm. This is due to the fact that, in case of a static stress, the damping effect of the elastic elements inserted under the cutting plate does not intervene.

Is also observed that, in all three situations, the maximum displacement is in the Z direction, a normal fact because the stress is also predominant in this direction.

4.2. Modal analysis

Figures 4.2, 4.3 and 4.4 show the graphs with the values of *natural vibration modes* or *natural frequencies* for tools T02 and T03 respectively.

Analyzing graphs 4.2, 4.3 and 4.4, it is easy to see that in all three cases the first natural mode of vibration appears somewhere around the value of 1470 Hz, a value that is far above the working frequency in the case of the turning operation. Of course, since the values of the frequencies for the eigenmodes of vibration are increasing, the other 5 eigenmodes are also not found in the working range of the lathe. Thus, I can state, with certainty, that there is no danger of resonance appearing in any of the presented models.

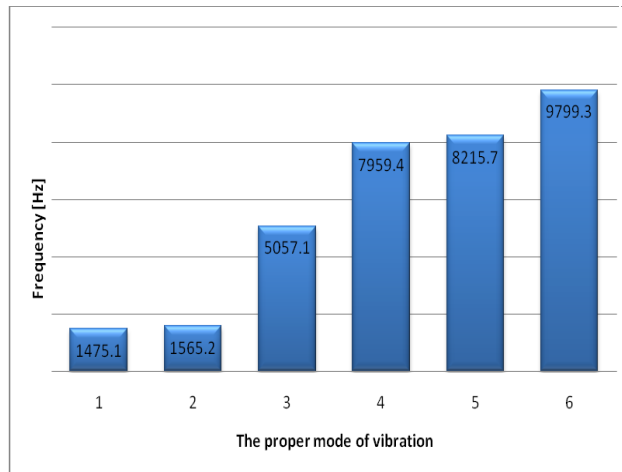

Figure 4.2. Numerical values of vibration eigenmodes for tool T01

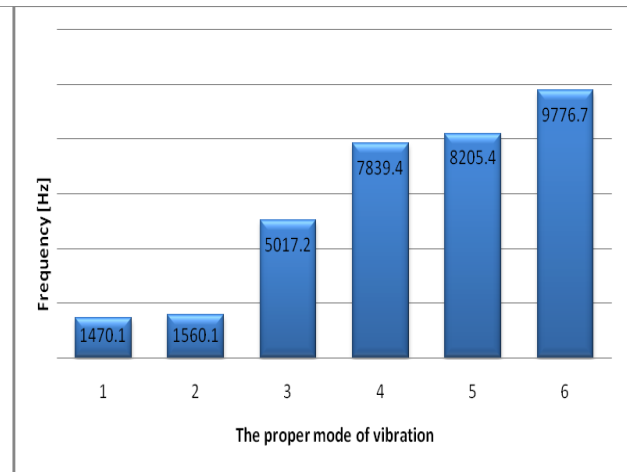

Figure 4.3. Numerical values of vibration eigenmodes for tool T02

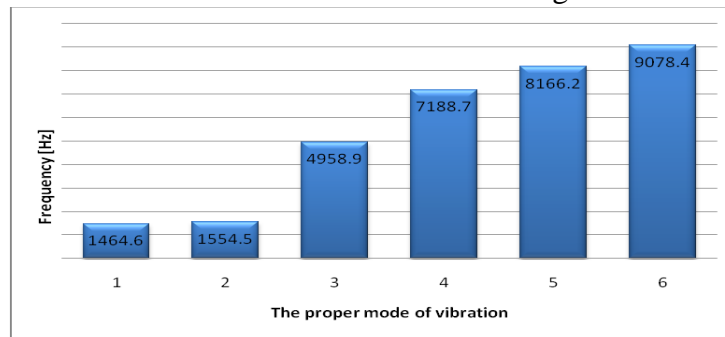

Figure 4.4. Numerical values of vibration eigenmodes for tool T03

For all three analyzed tools, the vibration trends for the 6 modes analyzed are: translation along the Y direction, at the first proper vibration mode, translation along the Z direction at the second proper vibration mode, rotation around the X axis, at the third natural mode of vibration, rotation around the Z axis, to the fourth natural mode of vibration, rotation around the Y axis, to the fourth natural mode of vibration, respectively translation along the X direction, to the sixth eigenmode of vibration.

If we carry out a comparative study between the three tool models, the classic tool and the two smart tools T02 and T03 respectively, it can be seen that the classic tool, T01 has the highest eigenmode values compared to the other two, followed by T02 and, of course, T03. This is due to the fact that, by introducing the elastic elements under the plate, its slenderness increases and because, as we mentioned before, the eigenmodes depend on the shape, mass and mode of support, it leads to a decrease in the value of the frequencies.

In conclusion, even if the values of the eigenmodes decrease in the smart tools T02 and T03 compared to the original tool T01, the decrease is only 5...6 Hz in the case of the first two eigenmodes, there is no danger of *resonance occurring*, the frequency value being sufficient large so as not to interfere with the working frequency range of the lathe.

4.3 . Harmonic analysis

Tables 4.1, 4.2 and 4.3 present the synthetic results of all 9 performed analyses.

Table 4.1 Maximum amplitude for material 42CrMo4 -EN 10083-3

42CrMo 4	Direction Z			Y direction			Direction X		
	Tool T01	Tool T02	Tool T03	Tool T01	Tool T02	Tool T03	Tool T01	Tool T02	Tool T03
	8.2957	7.2923	6.9014	1.4866	1.4293	0.7428	0.5393	0.5068	0.3821

Table 4.2 Maximum amplitude for material C45 (1.0503): EN 10277-2-2008

C45	Direction Z			Y direction			Direction X		
	Tool T01	Tool T02	Tool T03	Tool T01	Tool T02	Tool T03	Tool T01	Tool T02	Tool T03
	6.0667	5.4604	5.1957	1.0872	1.0655	1.0183	0.3706	0.3465	0.3142

Table 4.3 Maximum amplitude for material S235-EN 10025-2

S235	Direction Z			Y direction			Direction X		
	Tool T01	Tool T02	Tool T03	Tool T01	Tool T02	Tool T03	Tool T01	Tool T02	Tool T03
	5.5019	4.4303	5.3158	0.9859	0.8683	0.9153	0.3361	0.3276	0.3321

As can be seen in the tables shown , the maximum value in the Z direction occurs in the case of 42CrMo4 alloy steel, followed by C45 grade carbon steel and S235 carbon steel.

4.5. Conclusions

Following the numerical simulations , using the finite element method for the three models of cutting tools, the following conclusions can be drawn:

- numerical methods, in general, and the finite element method in particular, can be applied with conclusive results to the dynamic analysis of tools used in machining;
- the static analysis, in which a time-independent load of maximum value was applied for the cases considered, shows us that all three models of cutting tools behave very well in the case of a static stress, both nodal displacements and stresses and the deformations having values below those admissible for the materials used;
- the modal analysis applied to the three tool models shows us that, in all three cases, the values of the eigenmodes of vibration are found outside the working frequencies for the turning operation, for which they were designed, and therefore there is no risk of resonance in any from situations. The values of the natural vibration modes are close for the three situations, their lowest values being for tool T03, followed by T02 and T01 respectively. And the vibration trends for the first four modes remain the same, at least for the first four eigenmodes, for modes 5 and 6 differences appear between the T02 and T03 tools respectively compared to the T01 tool;

- harmonic analysis, applied to the three tool models , revealed slightly different behaviors between the three tool models. Thus, it can be observed that the T03 tool behaves best in the case of turning processing of alloyed, hard steels (42CrMo4) respectively of quality carbon steels (C45), while the T02 tool behaves best in the case of processing by turning of universal, unalloyed carbon steels (S235). It should be mentioned that, in the case of turning alloy steels (42CrMo4) and quality carbon steels (C45), the T02 tool was in second place, and in the case of carbon steels (C45 and S235), in second place the T03 tool was located, so both smart tools proposed by this thesis had better results than the initial, classic tool, in terms of vibration amplitude.



PERFORMANCE ANALYSIS OF THE USE OF CUTTING TOOLS WITH OPTIMAL FUNCTIONAL GEOMETRY FROM THE POINT OF VIEW OF VIBRATION

5.1. Overview

The vibrations were analyzed in the two directions (Y, Z), and the experimental results obtained for the vibration analysis using F.F.T. are presented for each material used in the research. In the case of the technological system consisting of a tool, part, device, processing machine, it is recommended that the vibration analysis be carried out in the frequency range 10 – 1000 Hz.

In many situations, the analysis of vibrations using only the F.F.T. method does not allow us a proper analysis of the vibration phenomenon, in the framework of the experimental research we performed a vibration analysis using the analysis method of the short-time Fourier transformation (Short-Time Fourier-Transformation) – the S.T.F.T. method but also the vibration signal analysis method (M.A.S.V.).

The S.T.F.T. method of vibration analysis allows a clearer highlighting of the vibrations that occur throughout the duration of the machining process because this analysis method also takes into account the time-based analysis of the vibrations.

The S.T.F.T. method allows drawing some spectrograms, and from the analysis of the spectrograms information can be obtained on how the vibrations evolve over time. The analysis of vibrations using only the analysis of stationary signals in a certain frequency domain is not sufficient, and thus the use of the S.T.F.T. method, which is a dynamic method of analysis, is always required.

Thus, the S.T.F.T. analysis also allows an analysis of transient signals, something that is not valid in the case of using the F.F.T. analysis. The S.T.F.T. analysis is based on the Discrete Fourier Transform (D.F.T) which provides information on the frequency and phase components of a section of a time-dependent signal .

5.2. Results obtained following research using cutting tools with optimal functional geometry for turning with transverse feed

5.2.1. Analysis of the experimental results obtained in the case of applying the analysis method of fast fourier transform (F.F.T.)

This summary presents the diagrams obtained after performing the F.F.T., S.T.F.T. and M.A.S.V. analysis for the processing of the S235- EN 10025-2 material by turning with transverse feed.

The same thing was done for the materials C45 (1.0503): EN 10277-2-2008 respectively 42CrMo4 -EN 10083-3 both in the case of machining with transverse feed and in the case of machining with longitudinal feed using the three models of cutting tools presented.

✓ **Material S235- EN 10025-2**

Following the processing by transverse feed turning of the 8 samples established according to the factorial research plan with the 3 types of cutting tools used T01, T02 and T03 respectively, the diagrams with the vibration amplitude values were obtained, shown in Figure 5.1 are the diagrams that contain the maximum values obtained when processing sample no. 5.

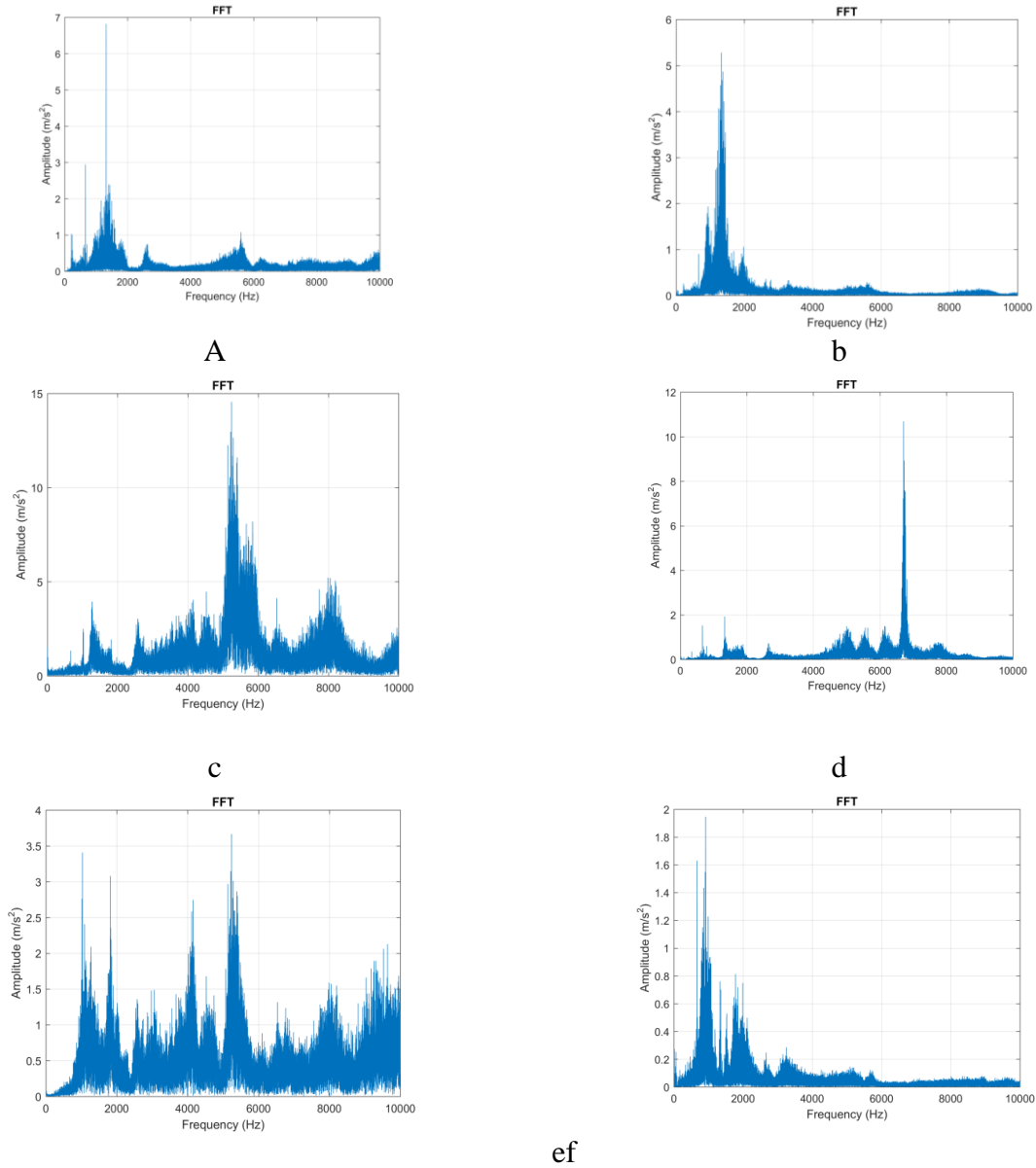
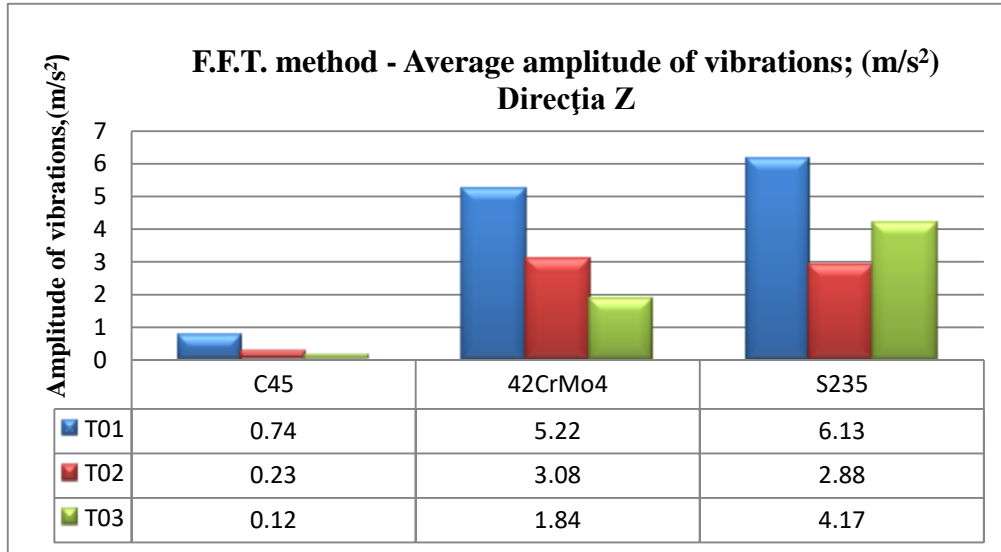
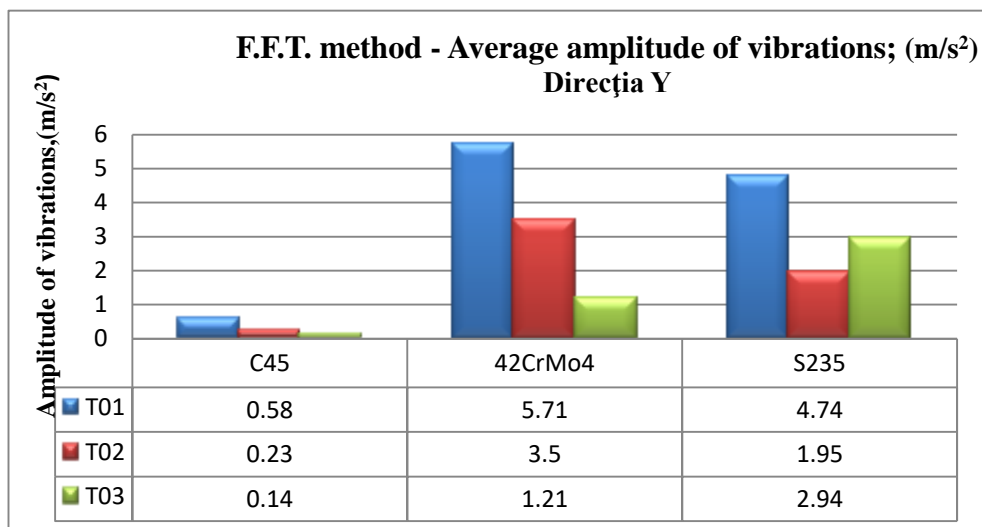

Figure 5.1. Vibration analysis by applying the F.F.T. method:
a – in the Z direction in the case of machining with a T01 cutting tool; b – in the Y direction in the case of processing with a T01 cutting tool; c – in the Z direction in the case of machining with a T02 cutting tool; d – in the Y direction in the case of machining with a T02 cutting tool; e – in the Z direction in the case of machining with a T03 cutting tool; f – in the Y direction in the case of machining with a T03 cutting tool



a.



b.

Figure 5.2. The results obtained by applying the F.F.T. method following the research of processing by turning with transverse advance a materials C45, 42CrMo4 and S235;

a – results obtained in the Z direction; b – results obtained in the Y direction.

5.2.2. Analysis of the experimental results obtained in the case of applying the analysis method a short time Fourier transform (S.T.F.T.)

Following the processing by turning with transverse advance of the 8 samples, established according to the factorial research plan, with the 3 types of cutting tools used: T01, T02, respectively T03, the spectrograms with the vibration amplitude values were obtained. Figure 5.3 shows the diagrams containing the maximum values obtained when processing sample no. 6.

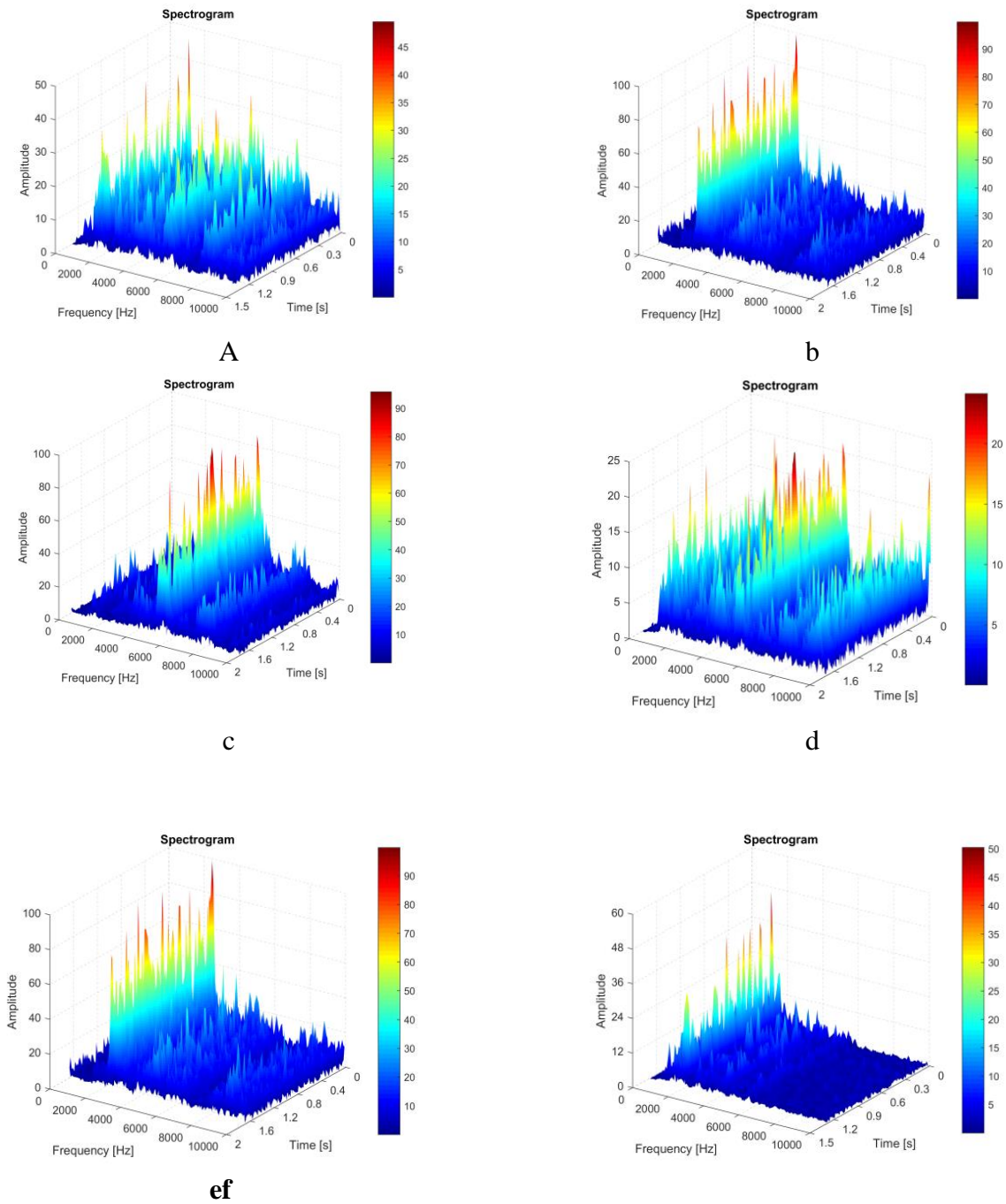
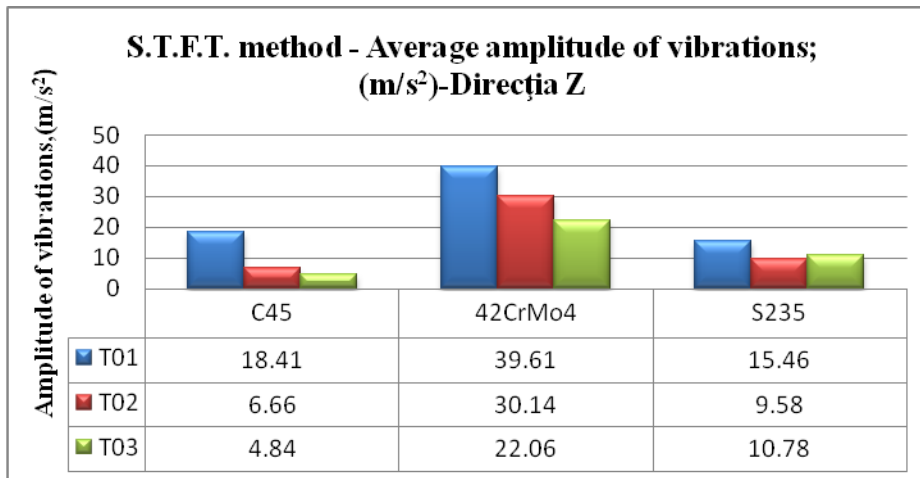
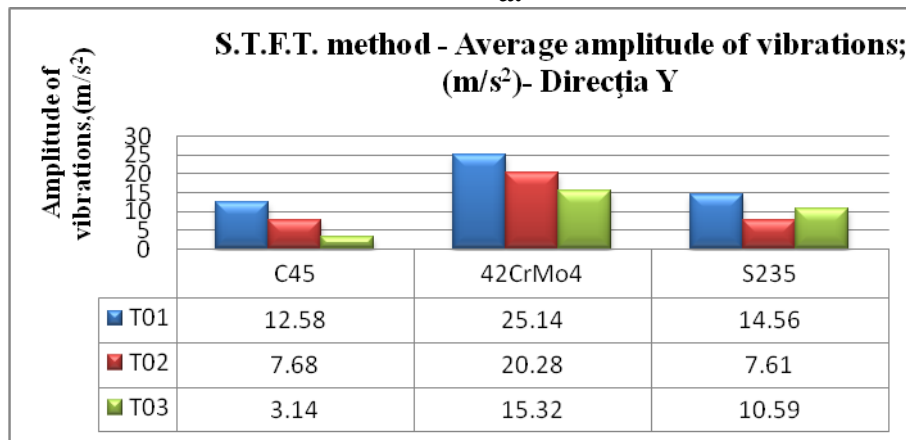

Figure 5.3. Vibration analysis by applying the S.T.F.T. method:
a – in the Z direction in the case of processing with the T01 cutting tool; b – in the Y direction in the case of machining with the T01 cutting tool; c – in the Z direction in the case of machining with the T02 cutting tool; d – in the Y direction in the case of processing with a T02 cutting tool; e – in the Z direction in the case of machining with the T03 cutting tool; f – in the Y direction in the case of machining with a T03 cutting tool



a.



b.

Figure 5.4 . The results obtained by applying the S.T.F.T. method following the research of processing by turning with transverse advance a materials C45, 42CrMo4 and S235;

a – results obtained in the Z direction; b – results obtained in the Y direction

5.2.3. Analysis of the experimental results obtained in the case of applying the analysis method of the vibration signal (M.A.S.V.)

✓ Material S235- EN 10025-2

After turning the 8 samples with transverse feed, according to the factorial research plan, using the 3 types of cutting tools (T01, T02 and T03), the diagrams with the vibration amplitude values were obtained. Figure 5.5 shows the diagrams with the maximum values of the vibration amplitude for sample no. 5.

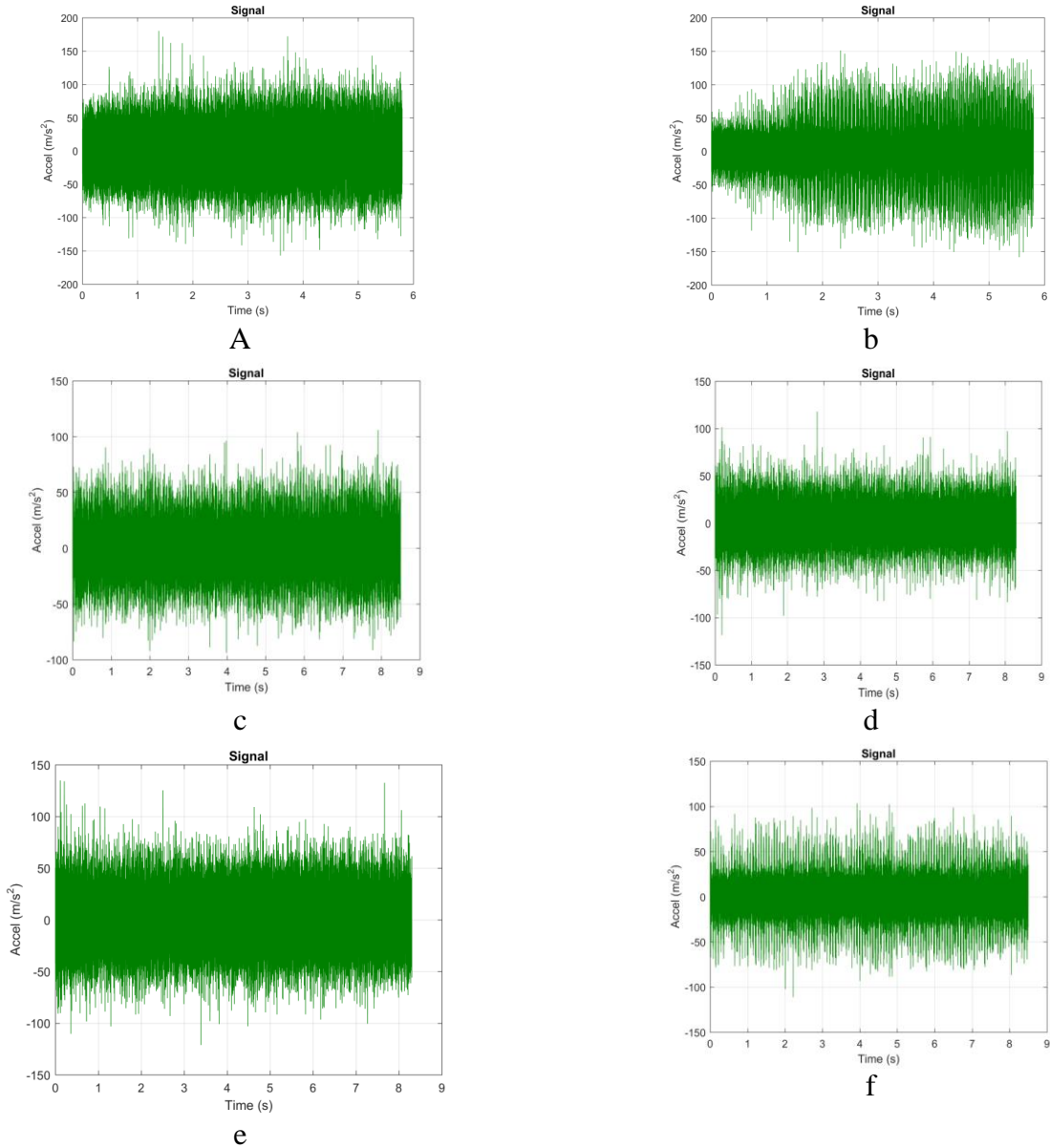
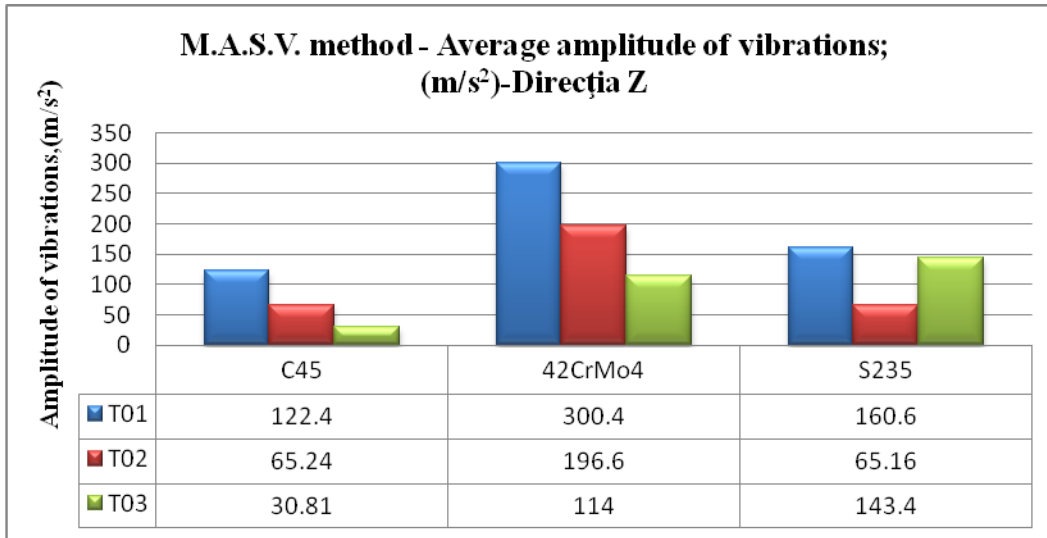
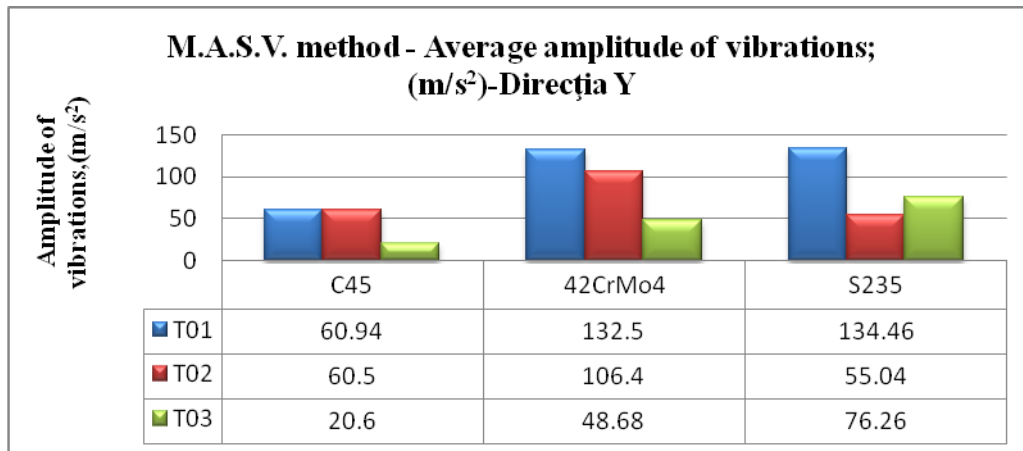

Figure 5.5. Vibration analysis by applying the M.A.S.V. method:
a – in the Z direction in the case of machining with a T01 cutting tool; b – in the Y direction in the case of processing with a T01 cutting tool; c – in the Z direction in the case of machining with a T02 cutting tool; d – in the Y direction in the case of processing with a cutting tool in the T02 variant; e – in the Z direction in the case of processing with a T03 cutting tool; f – in the Y direction in the case of processing with a cutting tool in the T03 variant



a.



b.

Figure 5.6. The results obtained by applying the M.A.S.V. method as a result of machining research with transversal feed turning of S235, C45 and 42CrMo4 materials;
a – results obtained in the Z direction; b – results obtained in the Y direction

5.3. Performance analysis of cutting tools with functional geometry optimal from the point of view of vibrations in the case of longitudinal turning

5.3.1. Analysis of the experimental results obtained using the Fast Fourier Transform (F.F.T.) analysis method

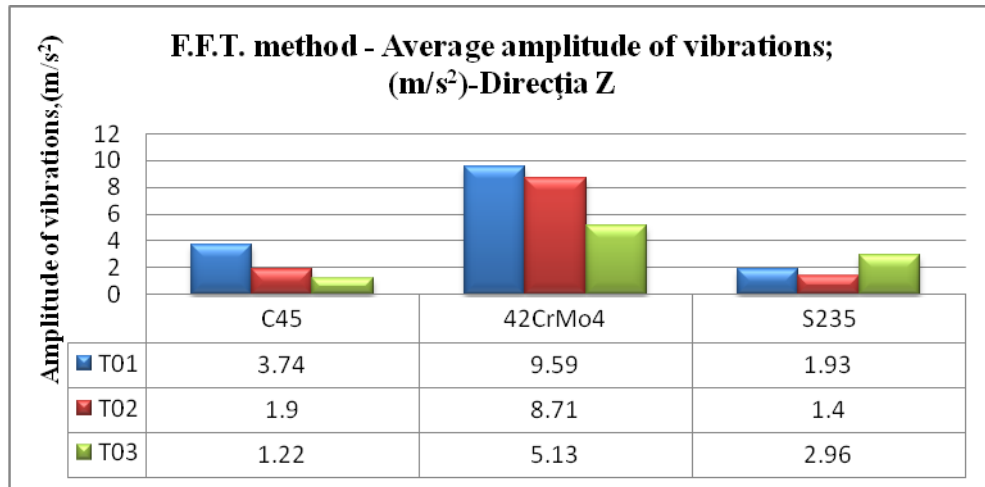

a.

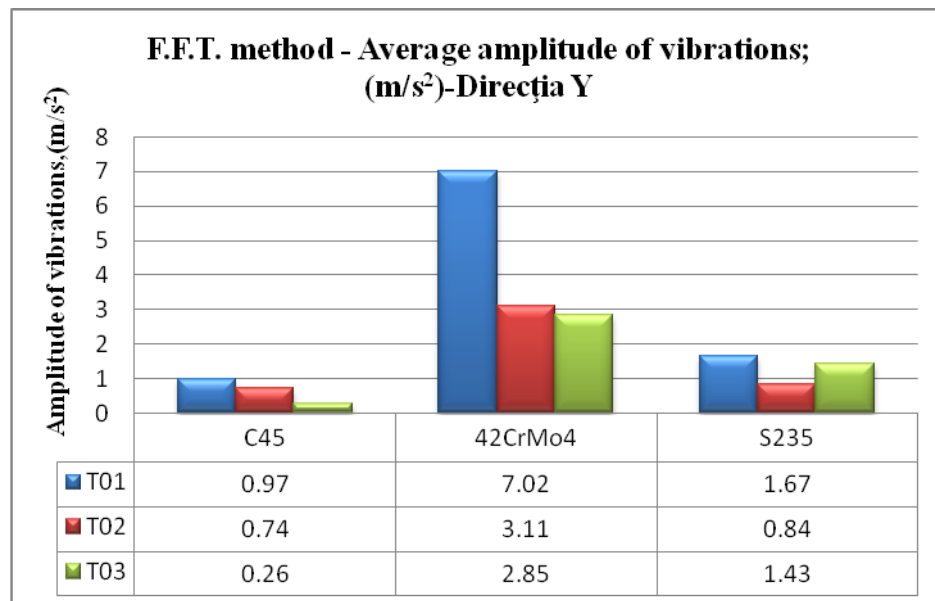

b.

Figure 5.7. The results obtained by applying the F.F.T. method following longitudinal turning machining research of S235, C45 and 42CrMo4 materials;
a – results obtained in the Z direction; b – results obtained in the Y direction

5.3.2. Analysis of the experimental results obtained in the case of the application of the Short Time Fourier-Transformation S.T.F.T. (Short Time Fourier-Transformation) analysis method

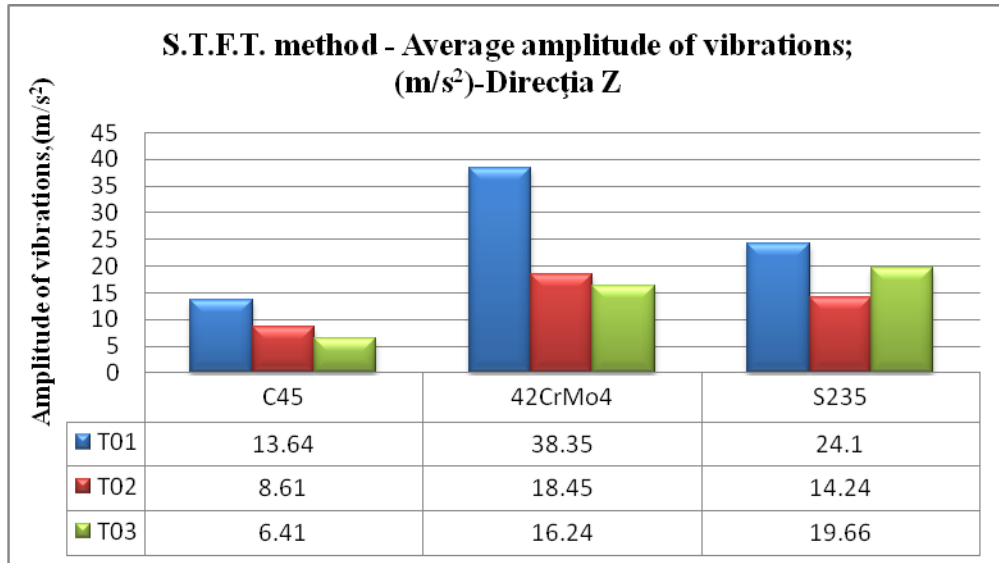

a.

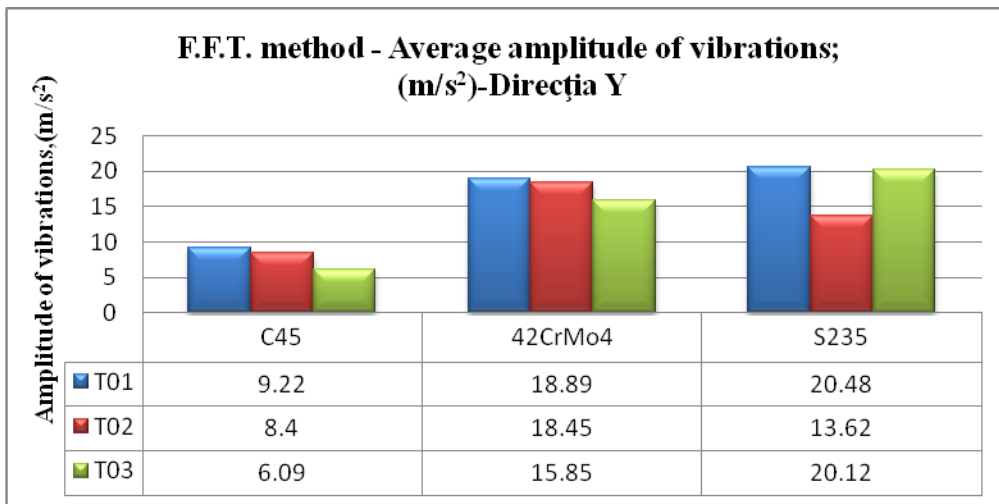

b.

Figure 5.8. The results obtained by applying the S.T.F.T. analysis method following research on processing by longitudinal turning of C45, 42CrMo4 and S235 materials;
a – results obtained in the Z direction; b – results obtained in the Y direction

5.3.3. Analysis of the experimental results obtained in the case of applying the analysis method of the vibration signal (M.A.S.V.)

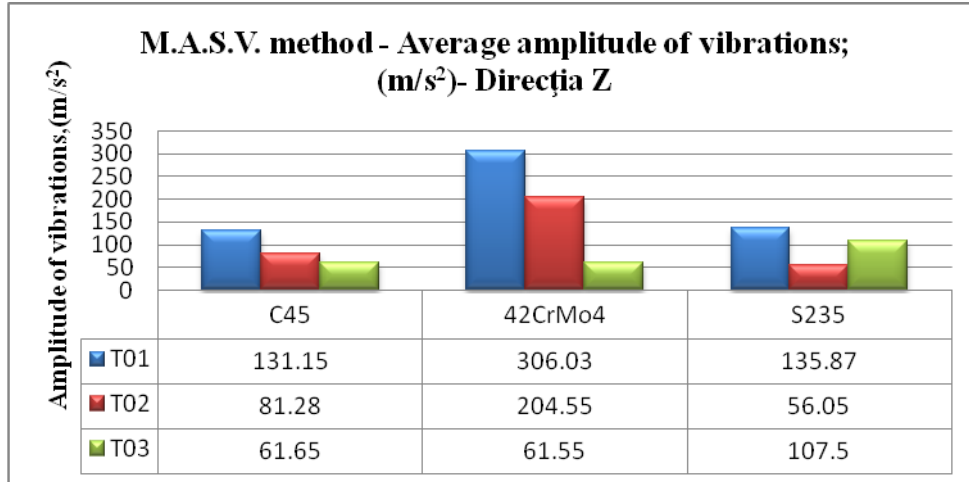

a.

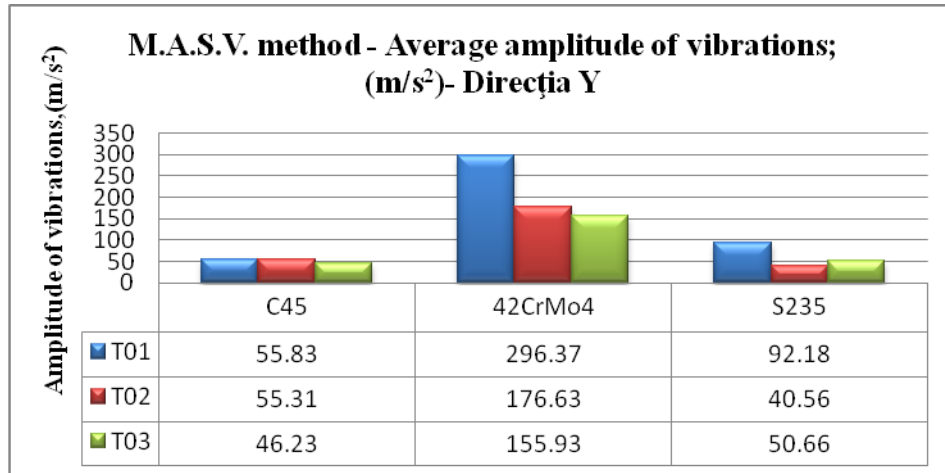

b.

Figure 5.9. The results obtained by applying the signal analysis method, (m/s²), following longitudinal turning machining research of materials C45, 42CrMo4 and S235;
a – results obtained in the Z direction; b – results obtained in the Y direction

5.4. Conclusions

- ✓ The researches have demonstrated the fact that the dynamic phenomena that accompany the processes machining are influenced by the type of cutting tool used.
- the research carried out had in mind a control of self-vibrations through the realization and the use of intelligent cutting tools of type T02, respectively T03, i.e. an improved construction variant in relation to the classic construction variant used for the T01 cutting tool.

Using the two 3 types of tools demonstrated the following:

➤ the use of tools T02 and T03 causes a reduction in amplitude vibrations compared to the situation in which the T01 tool was used. This can be explained by the fact that when using tools T02, respectively T03, the friction on the seating face, respectively the release face of the tool decreases a lot with consequences on the vibration amplitude.

➤ from the analysis of the results obtained by applying the FFT analysis method, the STFT analysis method and the vibration signal analysis method (MASV), mainly vibration values were obtained in the frequency range 10 - 1000 Hz due to the fact that the representative vibrations for such a mechanical system appear in this field, and the following have been demonstrated:

- in the case of the analysis using the FFT method the best results in all cases of analysis regarding the amplitude of vibrations in the Z direction were obtained by the improved tools T02 and T03 respectively. This can be explained by the fact that the use of improved tools T02, T03 determines the maintenance of an optimal geometry of the cutting tool, especially regarding the value of the angle α_{Fe} ;
- the results obtained regarding vibration amplitude in the Y direction under the FFT analysis method demonstrates the fact that the use of improved cutting tools T02 and T03 respectively have a greater effect on the reduction of vibrations in the Y direction comparable to the reduction of vibrations in the Z direction, and this can be explained by the fact that the use of improved cutting tools T02 and T03, respectively, causes the reduction of friction between the workpiece material and the clearance face of the tool by maintaining optimal values for the functional tool rake angle α_{Fe} .
- the analysis of the spectrograms (STFT analysis method) was carried out considering the frequency range 10 – 1000 Hz. Also, from the analysis of the spectrograms, the evolution over time of the vibration amplitude can be very easily observed, and this provides an image regarding the size of the vibration amplitude according to the processed diameter. Thus, from the analysis of the spectrograms, it was observed that the highest vibration amplitude occurs when the T01 cutting tool is used in the Z direction. This can be explained by the fact that the cutting forces have the highest values in the Z direction and thus in this direction the greatest frictional forces and implicitly the greatest amplitude vibrations can occur.
- from the analysis of the spectrograms, it is noted that at the end of the machining process, the amplitude of the vibrations decreases substantially in relation to the beginning of the machining process both in the Z direction and in the Y direction in the case of using the improved tools T02-T03. This can be explained by the fact that the use of improved T02 and T03 tools allows the damping of vibrations that occur in the cutting process.
- the results obtained from the analysis of vibration acceleration (MASV analysis method) recorded during machining confirm that the geometry of the cutting tool has a great influence on the vibrations that occur during the cutting process and demonstrate that the use of a cutting tool for processing of type T02, respectively T03, allows to maintain an optimal functional geometry during the entire duration of the processing process.
- the vibration amplitude values obtained following the application of the three analysis methods, the FFT method, the STFT method and the MASV method both in the case of turning with transverse feed and turning with longitudinal feed were processed with the help of the STATISTICA software, applying the method of multiple regression. That being said, the results obtained after processing the vibration values obtained by each cutting tool separately, T01, T02 and T03, using the multiple regression analysis

method, it emerges that in all analyzed situations the value of "p" is lower than 0.05, the multiple correlation coefficient "r" and the coefficient of determination "r square" (R^2) are greater than 0.9, for all analyzed situations, which confirms that the model fits the observed data, and the measure of the proportion of variation of the dependent variable, (amplitude of vibrations (m/s^2)), is validated by the independent variables (cutting depth, feed and cutting speed). Due to the fact that the value of "p" is less than 0.05, it confirms that the variation of the amplitude of the vibrations is not random, but has a valid real meaning. The values presented in the specified Tables confirm the fact that the independent variables have a different weight of influence on the dependent variables (amplitude of vibrations), and the descending order of influence differs depending on the processed material, thus their influence differs depending on the mechanical properties of the material to be processed.

- in all processing situations with tools T01, T02, respectively T03, these regression indicators confirm the validation of the obtained data, the independent variables having different weightings of influence for each tool in terms of the result obtained, but due to the construction of the cutting tools T02 and T03 a reduction of the vibration amplitude was obtained, also the values obtained were validated by the results of the multiple regression analysis.
- from the analysis of the graphical representations of the experimental results obtained during turning processing with transverse and longitudinal it appears that for all the materials studied both in the Z direction and in the Y direction, the vibration amplitude fluctuates with small values from one experiment to another in the situation of using the intelligent cutting tools T02 and T03, compared to the situation the results obtained by the T01 tool, where the distribution of values is much more uneven, which means that the intelligent tools T02 and T03 self-regulate and preserve their geometry during the machining process.

Thus, an inappropriate geometry of the cutting tool can cause an increase in the frictional forces between the face of the tool and the material of the part and implicitly the acceleration of vibrations.

The research carried out demonstrated the fact that the presence of an elastic element in the structure the cutting tool allows both vibration damping and permanent adjustment of its position so as to avoid an excessive decrease in the value of the angle α_{Fe} , managing to maintain the optimal functional geometry.

- following the interpretation of the results obtained by using the 3 analysis methods presented, it follows that the performances obtained by the improved tools T02 and T03 are influenced by the type of material processed, for some materials better results are obtained by the intelligent cutting tool T02, and for others by the T03 tool, which means that the T02 and T03 smart tools behave differently depending on the mechanical properties of the materials to be processed, depending on the machinability of the material by the degree of the deposition phenomenon on the edge of the cutting tool and the noise produced during the process cutting.
- also, the results obtained following the application of the multiple regression analysis highlight the fact that the independent variables a_p , f respectively V , have different weights of influence in terms of the order of influence, thus in the case of processing steel S235 the best performance in what concerns the vibration amplitude was achieved by the T02 cutting tool, and the descending order of influence of the independent variables is as follows: cutting depth, cutting speed, respectively feed, while when

processing steels C 45, respectively 42CrMo4, the order of influence is the following: depth of cut, feed and cutting speed, and the best results were obtained by the intelligent cutting tool T03.

- This demonstrates the fact that the properties of the materials to be processed influence the performances obtained by the intelligent cutting tools and also the order of influence of the dependent variables, a_p , f and V respectively.

PERFORMANCE ANALYSIS OF THE USE OF CUTTING TOOLS WITH OPTIMAL FUNCTIONAL GEOMETRY FROM THE POINT OF VIEW OF THE QUALITY OF THE SURFACES PROCESSED BY CUTTING

6.1. Overview

As part of the research, an analysis of the surface profiles was carried out, so as part of the processing of the obtained experimental data, a series of curves were drawn for each individual material used in the research as follows: curved profile; filtered profile; Abbott-Firestone curve.

Also, the experimental results obtained were represented graphically and were processed statistically with the help of the STATISTICA software through the multiple regression analysis method.

6.2. Results obtained as a result of machining research with transverse feed turning using cutting tools with optimal functional geometry

To carry out the experimental research, the cutting materials and parameters according to Table 2.2 were used, thus carrying out a number of 8 experiments, according to the factorial research method, described in chapter 2.

✓ Material S235- EN 10025-2

In order to analyze the roughness of the surfaces processed by turning with transverse feed, they have performed eight experiments according to the experimental research plan, detailed in Table 2.8.

The experiments were carried out under the same conditions, using the cutting tools T01, T02 and T03 respectively, shown in Figure 2.3. The roughness of the machined surfaces was measured for the S235-EN 10025-2-50 mm steel specimens. The roughness values obtained are shown in Table 6.1, and an image illustrating the shape of the roughness for the specimen with the highest values is shown in Figure 6.1.

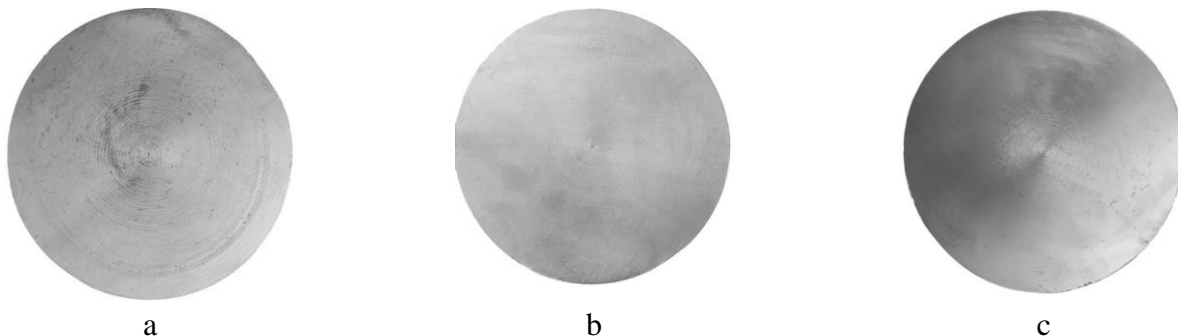
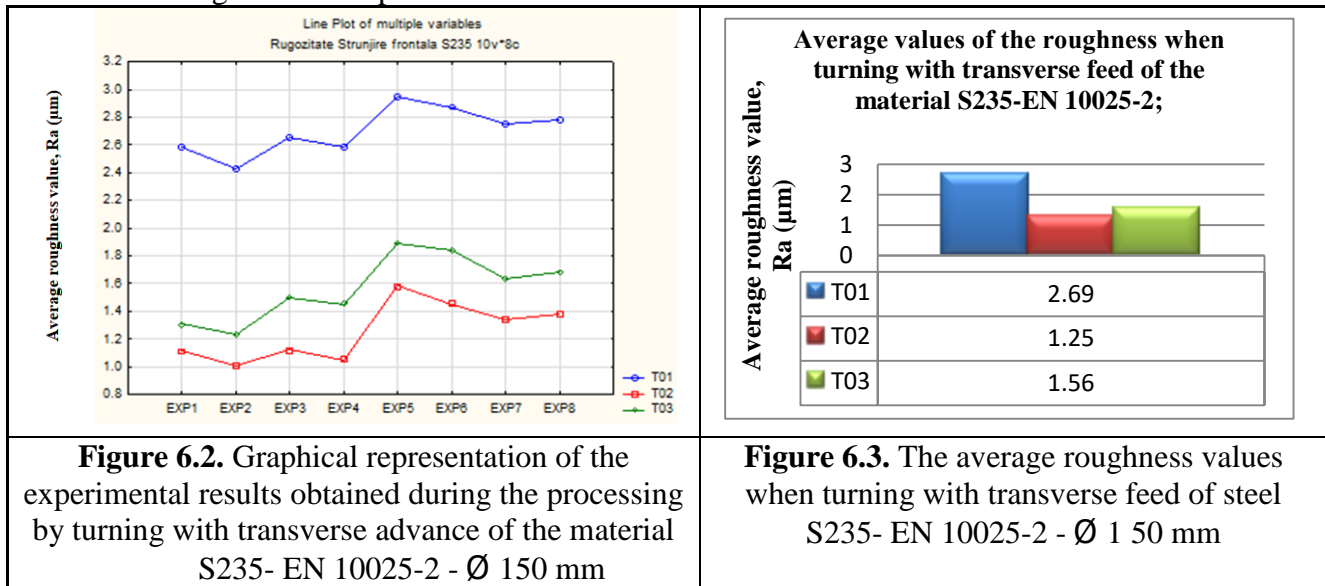

Figure 6.1. Images of surface roughness obtained by machining:
a – in the case of processing with a T01 cutting tool; b – in the case of machining with T02 cutting tool; c–in the case of machining with T03 cutting tool

Table 6.1. Measured roughness values for the 8 processed samples, Ra(μm)

No. Ex.	Material: S235- EN 10025-2 - \varnothing 1 50mm ;								
	The parameters of the cutting regime;						The measured roughness values, Ra (μm);		
	Cutting depth a_p [mm];		advance [mm/rot];		Average speed cutting [m/min];		The cutting tool used ;		
	0.9	3.6	0.2	0.36	90	120	The cutting tool T01	The cutting tool T02	The cutting tool T03
	-1	+1	-1	+1	-1	+1			
1	x		x		x		2.58	1.11	1.31
2	x		x			x	2.43	1.01	1.23
3	x			x	x		2.65	1.12	1.5
4	x			x		x	2.58	1.05	1.45
5		x		x		x	2.95	1.58	1.89
6		x		x	x		2.87	1.45	1.84
7		x	x			x	2.75	1.34	1.63
8		x	x		x		2.78	1.38	1.68
Average roughness value, Ra (μm);							2.69	1.25	1.56

The experimental results obtained following the realization of the research plan are represented graphically in Figure 6.2., and in Figure 6.3 the average roughness values obtained by the three cutting tools are represented.



The values of the roughness Ra (μm), measured on the surfaces processed with the three cutting tools T01, T02 and T03 respectively, were processed statistically using the specialized software STATISTICA, through the multiple regression method. The results of the multiple regression analysis for each cutting tool used are shown in Table 6.2.

Table 6.2. The parameters obtained after performing the multiple regression analysis applied for the roughness values $R_a(\mu\text{m})$, obtained during turning with transverse feed of the material S235-EN 10025-2 - \varnothing 150 mm

Cutting tool use	Material: S235- EN 10025-2 - \varnothing 150 mm ;						
	The values of the regression parameters obtained after performing the multiple regression analysis						
	R^2	F	df	p	$a_p b^*$	$f b^*$	$V b^*$
T01	0.929	17.66	3.4	0.009	0.930	0.468	-0.07
T02	0.920	15.52	3.4	0.01	0.868	0.229	-0.13
T03	0.987	106.81	3.4	0.0002	0.874	0.399	-0.05

The values obtained from the multiple regression analysis, quantified by the parameters $a_p b^*$, $f b^*$ and $v b^*$, reflect the different influences of the independent variables (cutting depth - a_p , feed - f and cutting speed - V) on the dependent variables, in this case the roughness of the processed surfaces, $R_a(\mu\text{m})$. According to the values presented in Table 6.2, the influence of the independent variables on the surface roughness of the material S235-EN 10025-2 - \varnothing 150 mm, is in descending order as follows: cutting depth, feed and cutting speed. From Tables 6.1 and 6.2 respectively, it can be seen that the T02 smart cutting tool achieved the best performance when processing this material. This is also confirmed by the vibration analysis, where the T02 tool also had the best results, demonstrating the link between the level of vibration and the quality of the surface obtained. In conclusion, the intelligent tools T02, respectively T03, improve the roughness of the surfaces processed by turning, with the best performance obtained by the tool T02 for the material S235-EN 10025-2 - \varnothing 150 mm. At the same time, in this chapter, an analysis of the surface profiles was carried out, and thus a series of curves were drawn for the material S235- EN 10025-2 - \varnothing 150 mm as follows:

- ✓ The curved profile, shown in Figure 6.4;
- ✓ The filtered profile, shown in Figure 6.5;
- ✓ The Abbott-Firestone curve, shown in Figure 6.6;

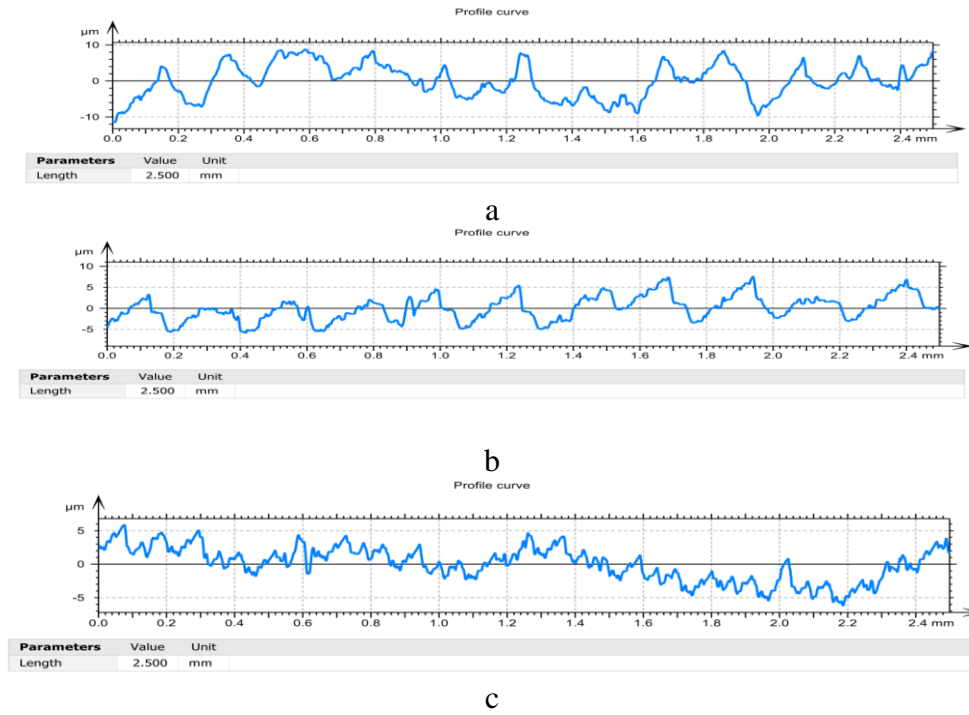

Figure 6.4. Curve profiles:
 a – in the case of machining with T01 cutting tool; b – in the case of processing with a T02 cutting tool; c – in the case of machining with T03 cutting tool

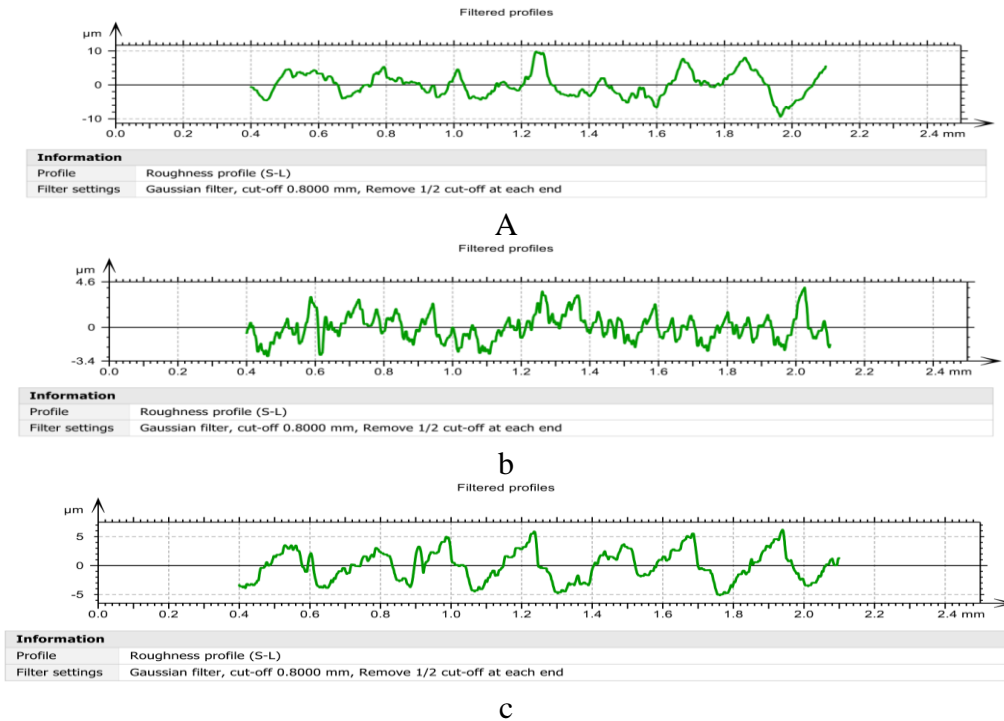

Figure 6.5. Filtered profiles:
 a – in the case of processing with a T01 cutting tool; b – in the case of processing with a T02 cutting tool; c – in the case of machining with T03 cutting tool

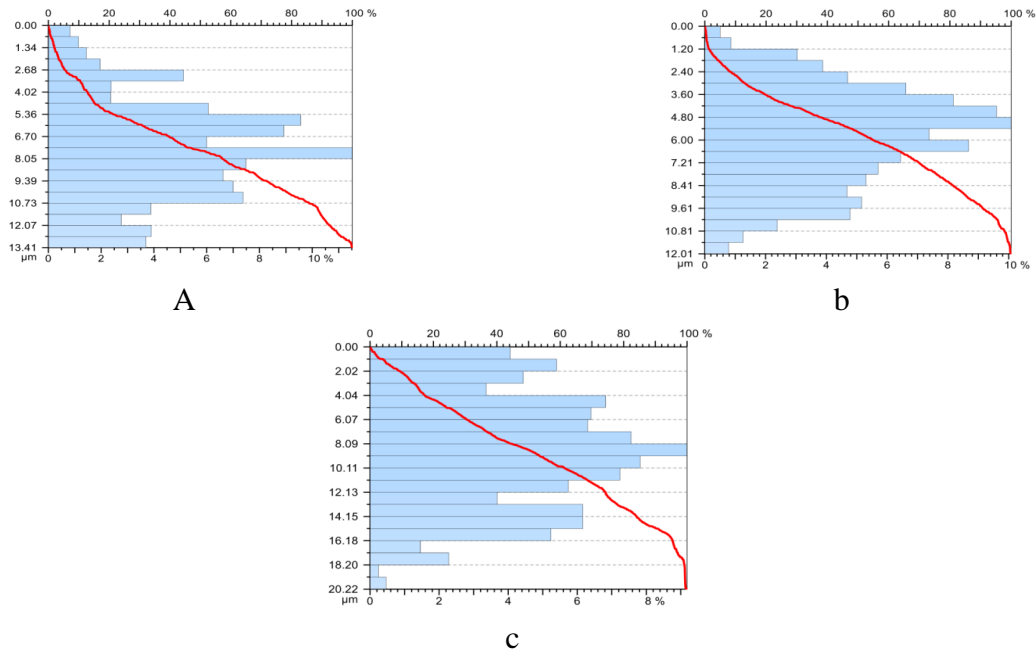

Figure 6.6. Abbott-Firestone curves:

a – in the case of machining with T01 cutting tool; b – in the case of processing with a T02 cutting tool; c – in the case of machining with T03 cutting tool

The research methodology and stages were the same for the processing of C45 materials (1.0503): EN 10277-2-2008 - Ø 150 mm; respectively 42CrMo4 -EN 10083-3 - Ø 150 mm

Figure 6.7 shows the average values of the roughness obtained during turning with transverse feed following the processing of materials C45 (1.0503): EN 10277-2-2008 - Ø 150 mm; 42CrMo4 -EN 10083-3 - Ø 150 mm; and S235- EN 10025-2 - Ø 150 mm;

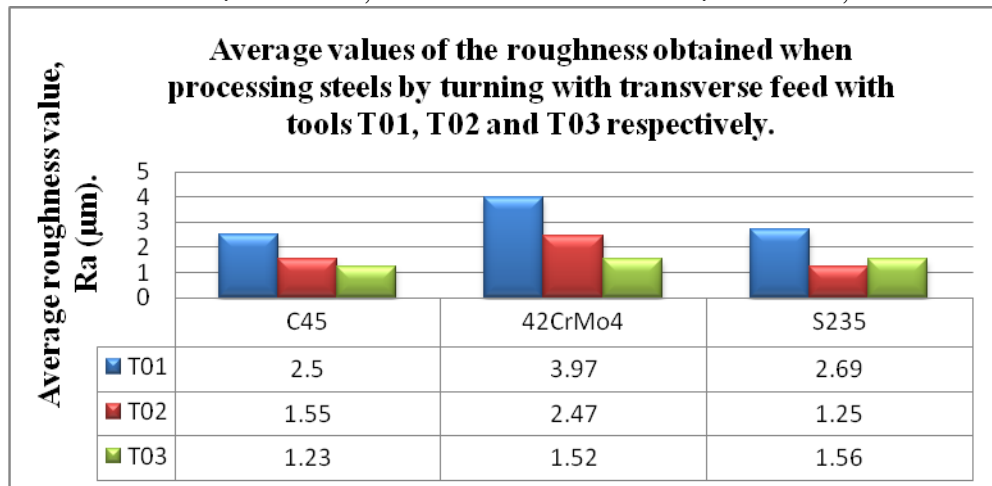

Figure 6.7. The average values of the roughness obtained during turning with transverse feed of C45 materials (1.0503): EN 10277-2-2008 - Ø 150 mm ; 42CrMo4 -EN 10083-3 - Ø 150 mm and S235- EN 10025 -2 - Ø 150 mm

In this way, the thesis deals with the performance analysis of the use of cutting tools with optimal functional geometry from the point of view of surface quality during the turning operation with transverse and longitudinal feed for all three materials C45 (1.0503): EN 10277-2-2008 - Ø 150 mm; 42CrMo4 -EN 10083-3 - Ø 150 mm and S235- EN 10025 -2 - Ø 150 mm used in research.

6.3. Performance analysis of the use of cutting tools with optimal functional geometry from the point of view of surface quality in the turning operation with longitudinal feed

In order to ensure the adequacy of the experimental research, 8 samples were processed according to the principle of factorial experiments for each cutting tool used, for each material used in the research, for which the roughness was measured.

The roughness of the obtained surfaces was measured for each type of tool used in processing (T01, T02, T03).

✓ Material S235- EN 10025-2

In order to analyze the roughness of the surfaces processed by longitudinal feed turning, eight experiments were carried out according to the experimental research plan. The experiments were carried out in turn, under the same conditions, using cutting tools T01, T02 and T03, shown in Figure 2.1. The roughness of the machined surfaces was measured for the steel samples S235- EN 10025-2- Ø 50mm .

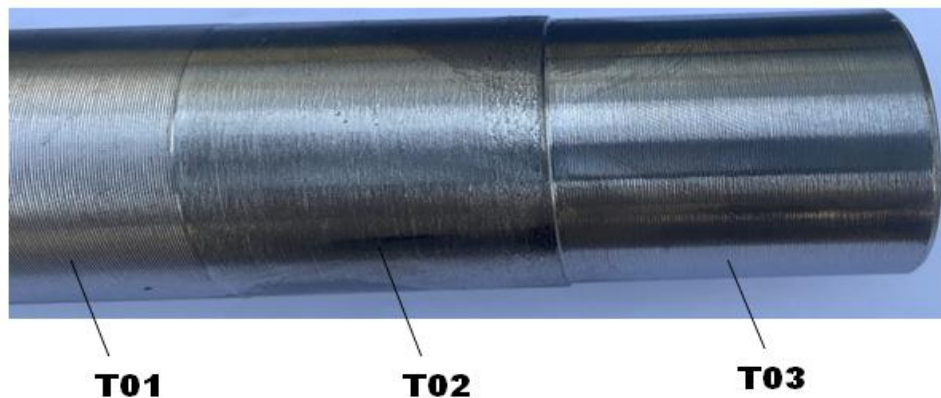

Figure 6.8. Image with the roughness of the surfaces obtained after turning with longitudinal feed by processing the material S235- EN 10025-2 - Ø 50mm

Figure 6.9 shows the average values of the roughness obtained during turning with longitudinal feed following processing of materials C45 (1.0503): EN 10277-2-2008 - Ø 50mm ; 42CrMo4 -EN 10083-3 - Ø 50mm , and S235- EN 10025-2 - Ø 50mm

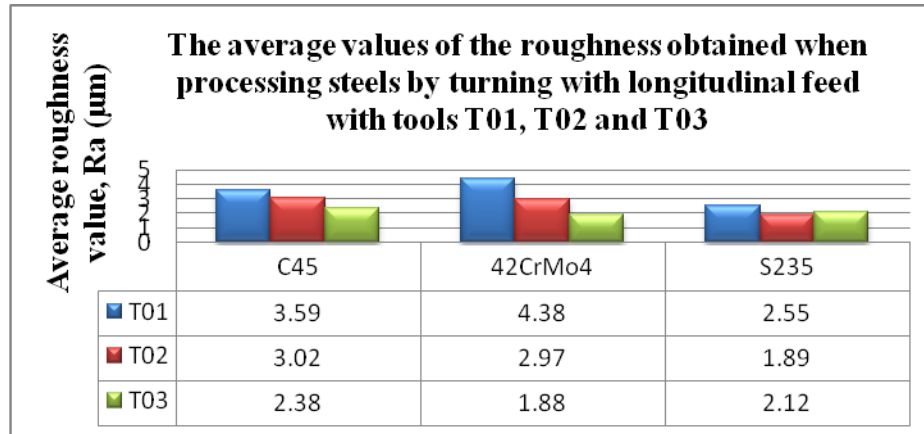

Figure 6.9. The average values of the roughness obtained after the turning operation with longitudinal feed of C45 materials (1.0503): EN 10277-2-2008 - Ø 50 mm; 42CrMo4 -EN 10083-3 - Ø 50 mm and S235- EN 10025 -2 - Ø 50 mm

6.4. Conclusions

- the research carried out during the realization of this doctoral thesis demonstrated the fact that the vibrations that accompany the machining process by chipping substantially influence the quality of the processed surfaces;
- the research considered a control of self-vibrations by making tools intelligent T02 and T03 respectively, which assume an improved construction variant compared to the classic construction variant used for the T01 cutting tool;
- the use of intelligent tools in the turning operation demonstrated the fact that they contributed to improving the quality of the parts' surfaces compared to processing with the classic T01 cutting tool;
- the results obtained from the measurement and analysis of the obtained roughnesses are in close correlation with the vibration analysis which demonstrated the fact that the use of intelligent tools T02 and T03 reduced the vibrations that occur during machining;
- in the case of turning processing with transverse feed, the analysis of the surface quality of the piece demonstrated that when the T01 tool was used, the roughness of the machined surface is higher than when using the T02 and T03 tools, and it has a tendency to increase sharply with the approach to the center of the part, something that correlates with the fact that with the decrease of the diameter to be processed, the geometry of the cutting tool varies the most;
- thus, the use of intelligent tools T02 and T03, when turning with transverse feed, allows obtaining an approximately constant roughness on the entire surface without large differences in roughness between the area of the surfaces arranged towards the inside and outside of the piece;
- the results obtained after processing the values obtained with the help of the analysis method multiple regression, demonstrates a real valid significance of the obtained experimental results;
- research has demonstrated the advantages offered by the use of T02 and T03 smart tools, from the point of view of vibration control and implicitly on the quality of the surfaces.



PERFORMANCE ANALYSIS OF THE USE OF CUTTING TOOLS WITH OPTIMUM FUNCTIONAL GEOMETRY FROM THE POINT OF VIEW OF THE FORCES AND POWER CONSUMED FOR CUTTING

7.1. Overview

In particular, the modification of the values of the cutting forces is determined by ensuring an optimal geometry of the cutting tool throughout the cutting process. The analysis of the values of the cutting forces is a very good method of evaluating the phenomena that accompany the cutting process. Thus, their values provide information on the degree of stress on the cutting edge of the tool, but also on the frictional forces that accompany any cutting process

7.2. Performance analysis of the use of cutting tools with optimal functional geometry in terms of cutting forces in the case of turning with transverse feed

presented in Table 2.1 were used, thus making a number of 8 experiments according to the factorial research method described in chapter 2.

✓ Material S235- EN 10025-2

After carrying out the experiments established according to the experimental research plan for the material S235-EN 10025-2, having a diameter of 150 mm, the values of the three components of the cutting forces (F_c , F_f and F_p) obtained when processing with the three variants of cutting tools are shown in Table 7.1 for F_c , Table 7.2 for F_f and Table 7.3 for F_p . Thus, the measured values for the main component of the cutting force (F_c) are detailed in Table 7.1, where the differences are observed according to each type of tool used (T01, T02 and T03 respectively). Table 7.2 shows the values of the feed component of the cutting force (F_f), which reflect the variations resulting from machining with different values of the longitudinal feed. Finally, Table 7.3 presents the values of the cutting force component in the transverse direction (F_p), illustrating the influence of the tools on this component in the machining process.

The analysis of these values helps to understand the behavior of the tools during the cutting process and to optimize the machining parameters in order to obtain as little roughness as possible and as much process stability as possible.

Table 7.1. The values of the component F_c for the 3 types of cutting tools, daN

No. Ex.	Material: S235- EN 10025-2 - Ø 150 mm ;								
	The parameters of the cutting regime						The value of the measured force [daN].		
	Cutting depth a_p [mm]		advance [mm/rot]		Average speed of splintering [m/min]		The value of the component F_c		
	0.9	3.6	0.2	0.36	90	120	The cutting tool T01	The Cutting tool T02	The cutting tool T03
	-1	+1	-1	+1	-1	+1			
1	x		x		x		68.79	61.86	62.89
2	x		x			x	69.87	63.97	66.58
3	x			x	x		98.78	94.42	97.85
4	x			x		x	95.87	98.75	91.59
5		x		x		x	415.89	397.85	400.85
6		x		x	x		410.18	383.58	398.75
7		x	x			x	298.75	247.45	269.87
8		x	x		x		287.59	239.82	251.59
The average value of the cutting force							218.21	198.46	204.99

Table 7.2. The values of the F_f component for the 3 types of cutting tools, daN

No. Ex.	Material: S235- EN 10025-2 - Ø 150 mm ;								
	The parameters of the cutting regime						The value of the measured force [daN].		
	Cutting depth a_p [mm]		advance [mm/rot]		Average cutting speed [m/min]		The value of the component F_f		
	0.9	3.6	0.2	0.36	90	120	The cutting tool T01	The cutting tool T02	The cutting tool T03
	-1	+1	-1	+1	-1	+1			
1	x		x		x		19.53	17.58	19.05
2	x		x			x	20.87	18.25	19.35
3	x			x	x		23.08	20.14	22.58
4	x			x		x	21.58	18.97	20.91
5		x		x		x	96.87	89.05	94.05
6		x		x	x		93.12	87.05	91.05
7		x	x			x	78.12	92.05	96.28
8		x	x		x		75.18	69.05	72.05
The average value of the cutting force							53.54	51.51	54.41

Table 7.3. The values of the F_p component for the 3 types of cutting tools, daN

No. Ex.	Material: S235- EN 10025-2 - Ø 150 mm ;								
	The parameters of the cutting regime						The value of the measured force [daN].		
	Cutting depth a_p [mm]		advance [mm/rot]		Average cutting speed [m/min]		The value of the F_p component		
	0.9	3.6	0.2	0.36	90	120	The Cutting tool T01	The cutting tool T02	The cutting tool T03
	-1	+1	-1	+1	-1	+1			
1	x		x		x		14.28	10.87	11.25
2	x		x			x	15.28	11.53	12.25
3	x			x	x		16.59	14.45	16.58
4	x			x		x	16.35	13.25	14.58
5		x		x		x	67.81	60.15	62.58
6		x		x	x		65.89	58.64	61.89
7		x	x			x	49.87	43.48	45.87
8		x	x		x		47.41	40.25	41.69
The average value of the cutting force							36.68	31.57	33.33

The results of the values of the forces F_c , F_f , F_p , (daN), obtained as a result of turning the material S235- EN 10025-2 - Ø 150 mm with the help of cutting tools T01, T02 and T03 respectively, were processed statistically using the specialized software STATISTICA, through the multiple regression method, and the results obtained following the multiple regression analysis for each cutting tool used are presented in Table 7.4.

Table 7.4. The parameters obtained after performing the multiple regression analysis applied for the force values F_c , F_f , F_p , (daN), obtained when turning with transverse feed of the material S235- EN 10025-2 - Ø 150mm

rise use	Material: S235- EN 10025-2 - Ø 150 mm ;							
	The values of the regression parameters obtained after performing the multiple regression analysis,							
	The component of the cutting force F_c ,							
	R^2	F	df	p	$a_p b^*$	$f b^*$	$V b^*$	
T01	0.973	48.81	3.4	0.0013	0.951	0.347	0.027	
T02	0.952	26.60	3.4	0.0042	0.912	0.26	0.013	
T03	0.958	30.54	3.4	0.0032	0.927	0.313	0.016	
The component of the cutting force F_f ,								
T01	0.983	81.73	3.4	0.0004	0.982	0.155	0.093	
T02	0.976	55.44	3.4	0.001	0.979	0.068	0.025	
T03	0.975	53.57	3.4	0.001	0.980	0.079	0.092	
The component of the cutting force F_p ,								
T01	0.964	36.08	3.4	0.0023	0.955	0.268	0.029	
T02	0.964	35.80	3.4	0.0023	0.946	0.226	0.023	
T03	0.966	38.27	3.4	0.0021	0.949	0.251	0.027	

According to the data presented in Table 7.4, obtained after processing the values of the components of the cutting force (F_c , F_f , F_p) through the statistical method of multiple regression analysis, it is observed that the influence of the independent variables (the depth of cutting - a_p , the advance - f and the cutting speed - V), quantifiable by means of the regression parameters $a_p b^*$, $f b^*$ and $v b^*$, varies depending on the cutting tool used: T01, T02 and T03 respectively.

For the processing of the material S235-EN 10025-2 - \varnothing 150 mm, the best results were obtained with the T02 chipping tool. Also, the T03 smart chipper outperformed the T01 chipper but underperformed the T02 chipper. The superior performances of the T02 and T03 smart cutting tools are validated by the values presented in Table 7.1 (for the F_c component), Table 7.2 (for the F_f component) and Table 7.3 (for the F_p component). Thus, when processing the material S235-EN 10025-2 - \varnothing 150 mm, the intelligent cutting tool T02 achieved the best performance both in terms of reducing the processing forces and in terms of the roughness of the processed surfaces and the vibration amplitude.

These results demonstrate that there is a significant relationship between the vibration level, the roughness of the machined surfaces and the cutting forces. The use of smart tools, especially T02, not only reduces cutting forces, but also improves the quality of machined surfaces, which indicates an optimization of the machining process by reducing vibrations and ensuring optimal cutting parameters. The research methodology was also continued for C45 materials (1.0503): EN 10277-2-2008 - \varnothing 150 mm ; respectively 42CrMo4-EN 10083-3- \varnothing 150 mm

The values of the components of the cutting forces were also determined in the longitudinal feed machining research for all the materials under study. The average values of the measured forces (F_c , F_f , F_p) for each type of cutting tool and material used were centralized and are shown in Figure 7.1 and 7.2 respectively

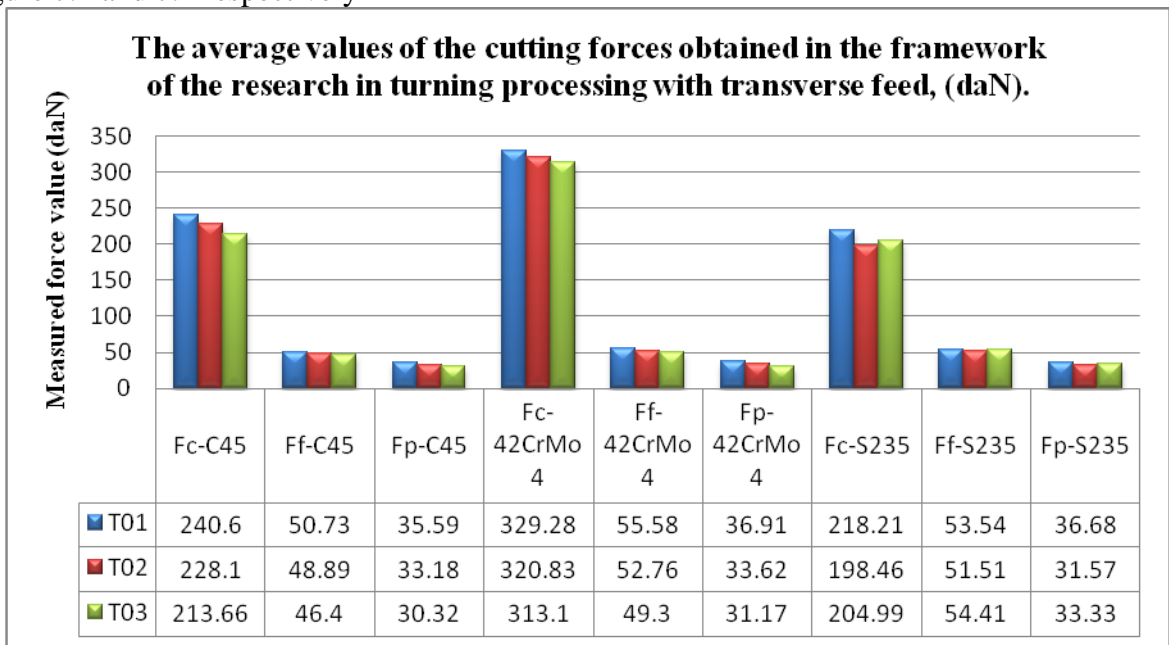

Figure 7.1. The average values of the components of the cutting forces obtained as a result of the research on the processing by turning with transverse advance of the materials C45 (1.0503): EN 10277-2-2008 - \varnothing 150 mm ; 42CrMo4-EN 10083-3- \varnothing 150 mm and S235- EN 10025-2 - \varnothing 150 mm

7.3. Performance analysis of the use of cutting tools with optimal functional geometry in terms of cutting forces in the case of turning with longitudinal feed

The average values of the measured forces (F_c , F_f , F_p) for each type of cutting tool and material used were centralized and are presented in Figure 7.2, providing a clear overview of the efficiency of each tool in various machining conditions.

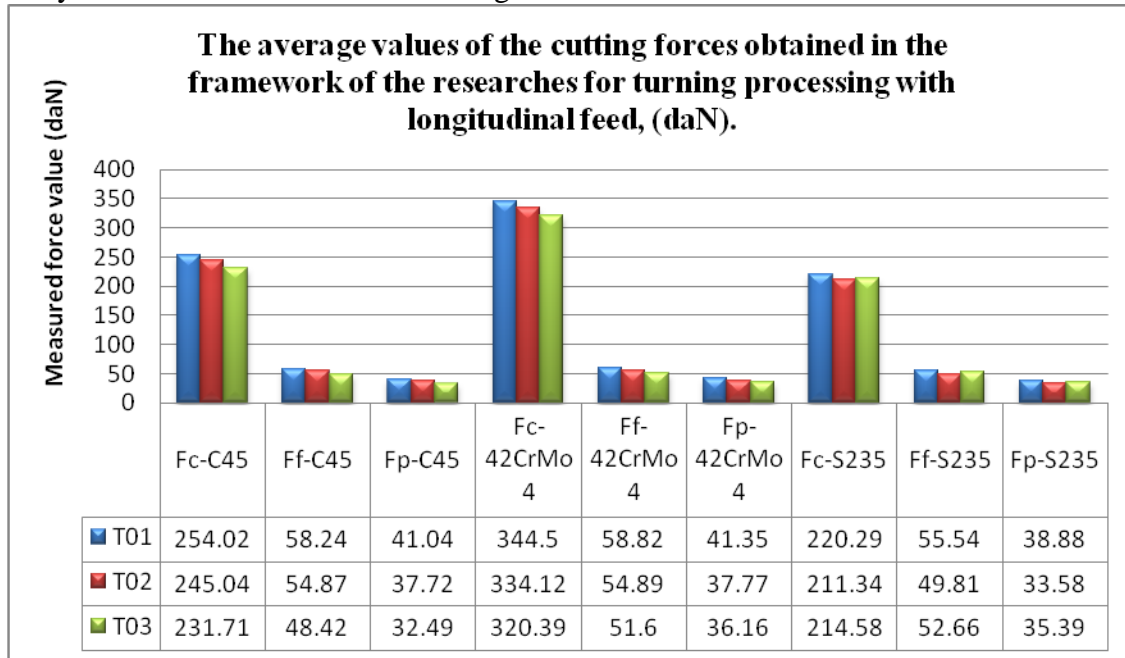

Figure 7.2. The average values of the components of the cutting forces obtained as a result of the research on the machining of materials with longitudinal feed turning C45 (1.0503): EN 10277-2-2008 - Ø 50 mm; 42CrMo4-EN 10083-3- Ø50 mm and S235- EN 10025-2 - Ø 50 mm

7.4. Conclusions

- the carried out research aimed at the design of a processing system by chipping the materials that would allow the reduction of energy consumption under the conditions of decreasing vibration values and increasing the quality of the processed surfaces;
- thus, it was demonstrated that there is the possibility of reducing energy consumption and transforming the processing process into an eco-process; also, the steps taken in the research allowed establishing the optimal conditions for which the lowest energy consumption and the lowest roughness of the processed surfaces can be obtained.

Ecodesign of the material cutting process demonstrates the following:

- in the case of using the T02-T03 smart cutting tool variants, an optimal tool geometry can be achieved due to the fact that the insert can self-adjust its position and thus a considerable reduction of the cutting forces was obtained, and this reduction is very useful especially in the case of the main component of the cutting force F_c ;

- the maximum reduction of the cutting forces was approximately 20%, and this reduction also allows a decrease in the cutting power and implicitly in the amount of energy consumed;
- through the constructive improvement brought to the chipping tool, a reduction in the size of the frictional forces and implicitly in the amount of heat generated during chipping is obtained;
- the effect of the constructive changes brought to the cutting tool also causes a reduction in the intensity of the adhesion phenomenon of the material to be processed on the tool edge;
- by reducing the adhesion of the processed material on the cutting edge of the tool, an improvement in the surface roughness of the part was also achieved, thus achieving a correlation between energy consumption and surface roughness ;
- there is the possibility of choosing the design parameters that allow the transformation of the processing process into an eco-process ;
- experimental research demonstrated that the intelligent tools created behaved differently, depending on the processed material, thus for certain materials (C45 and 42CrMo4) better results were obtained for the intelligent cutting tool T03, a fact that also correlates with the results obtained in the vibration measurement and roughness measurement phase ;
- this is explained by the fact that for materials with high mechanical properties the best performances were obtained by the T03 type intelligent tools with 2 elastic elements mounted in the package, compared to the situation when for materials with lower mechanical properties the tool behaved better intelligent chipper T02 , consisting of a single elastic element ;
- the results obtained from the regression analysis highlight the fact that the order of influence of the independent variables a_p , f , respectively V , differs depending on the mechanical properties of the material to be processed, this also being preserved within the analysis of the vibration amplitude and surface roughness processed , for the processing of C45 and 42CrMo4 materials, the order of influence is as follows: cutting depth, feed and cutting speed, while when processing S235 material, the cutting speed has a greater weight than the feed, the cutting depth being the one that has the biggest weight of influence for all processed materials ;
- the presented research demonstrated the importance of using smart cutting tools for the cutting process;
- future research will aim to analyze the possibilities of applying the results obtained for other types of tools, respectively processing procedures.

CHAPTER 8



CONCLUSIONS, ORIGINAL CONTRIBUTIONS AND FUTURE RESEARCH DIRECTIONS

8.1. General conclusions of the doctoral thesis

Following the analyzes and interpretations of the obtained results , in the framework of the theoretical and experimental research carried out, the following conclusions are drawn:

- the variation of the functional geometry creates negative effects on the results of the machining processes;
- the variation of the functional geometry leads to the removal of the values of the geometric parameters outside the optimal allowed values, which leads to the increase of the amplitude of the vibrations, the increase of the roughness of the processed surfaces corresponding to the increase of the cutting forces, also influencing the increase of the energy consumption necessary for the realization of the cutting process;
- intelligent cutting tools have positive effects compared to the classic cutting tool in terms of vibration amplitude, roughness of machined surfaces and cutting forces;
- the trajectories traveled by the tip of the tools in order to generate the surfaces present a considerably greater deviation from the theoretical trajectory in the case of using the classic cutting tool compared to the situation where the intelligent cutting tool is used both in the case of transverse turning and in the case of turning with longitudinal feed, with the mention that the deviation from the theoretical profile is greater in the case of turning with transverse feed and increases a lot with the decrease of the diameter to be processed ;
- regarding the vibration amplitude, regardless of the analysis method used (F.F.T method, S.T.F.T method and M.A.S.V method), the intelligent cutting tools obtained the reduction of the vibration amplitude compared to the classic cutting tool;
- the intelligent cutting tools T02 and T03, respectively , obtained different performances, these performances being influenced by the type of processed material. So the intelligent cutting tool T03 obtained superior performances when processing steels with high mechanical properties (C45 and 42CrMo4 respectively), and the intelligent cutting tool T02 obtained superior performances when processing steel S235, whose mechanical characteristics are inferior to the other categories of materials used;
- the values obtained for the amplitude of the vibrations were statistically processed by the method of multiple regressions, the results obtained demonstrate the validity of the amplitude values for each cutting tool used, but the best results obtained following the processing by multiple regression quantified by means of the regression parameters a_{pb}^* , fb^* and vb^* confirm that the T02 intelligent cutting tool achieves the best performance in machining S235 material in both cross-feed turning and longitudinal feed turning, and the intelligent cutting tool achieved the best performance when processing 42CrMo4 and C45 materials for turning with transverse feed as well as for turning with longitudinal feed;

- the descending order of influence of the independent variables, a_p , f and V on the amplitude of vibrations was the following: a_p , v and f regarding the S235 material, respectively a_p , f and V regarding the processing of materials C45, respectively 42CrMo4
- In terms of roughness, the performances of the smart cutting tools are better compared to the classic T01 cutting tool in all machining situations, but when machining the S235 material, the best performance was also obtained by the T02 smart cutting tool, while the T02 cutting tool intelligent T03 achieved remarkable performances when processing C45 and 42CrMo4 steels, which is in close correlation with the results obtained in the vibration analysis;
- as well as vibration analysis, intelligent cutting tools have obtained different performances depending on the processed material, which confirms that there is a link between the characteristics of the processed material, vibrations and roughness;
- the multiple regression analysis validated the values obtained for roughness and established the order of influence of the independent values, a_p , f and V on the roughness, the order being different depending on the processed material, the influence following the same order as in the vibration analysis for the processing of the three materials S235, C45 and 42CrMo4 respectively, which demonstrates the existence of a direct link between the vibration amplitude and roughness;
- regarding the values of the cutting forces, the obtained results demonstrate the fact that the intelligent cutting tools have achieved a reduction of the cutting forces compared to the classic T01 cutting tool, values that are validated by the multiple regression results; the same situation for vibration analysis and roughness analysis and in the case of force analysis, the T02 cutting tool obtained the best results when processing the S235 material, and the T03 intelligent cutting tool when processing the C45 material, respectively 42CrMo4; the order of influence of the independent variables, a_p , f and V being given by the values of the regression parameters $a_p b^*$, $f b^*$ and $v b^*$ and is as follows: for the S235 material, their descending order is a_p , V and f , and as regards the processing of C45 materials, respectively 42CrMo4, the order is of a_p , f and V ;
- the interpretation of the experimental results obtained and processed with the help of multiple regression analysis for the analysis of vibration amplitude, roughness and cutting forces highlight the link that exists between these three dependent variables, because for each variable in part the cutting tools obtained the best values, thus that the T02 tool obtained the best values when processing S235 material, and the T03 tool when processing C45 materials, respectively 42CrMo4; the descending order of the independent variables, a_p , f and V was kept constant for the processing of the three materials, in terms of vibration amplitude and cutting force;
- both for turning with transverse feed and for turning with longitudinal feed, the order of influence is given by the properties of the material to be processed, and the performance of smart cutting tools is influenced by the characteristics of the material to be processed; thus for each dependent variable (vibration amplitude, roughness respectively cutting force) the descending order of influence of the independent variables is a_p , V and f when processing the S235 material, where the best performance was achieved by the T02 tool, respectively when processing materials C45, respectively 42CrMo4, the descending order of influence on the amplitude of vibrations and cutting forces is as follows: a_p , f and V for turning with transverse feed, respectively with longitudinal feed.

All these results demonstrate the connection between vibration amplitude, roughness respectively cutting forces and also demonstrate the performance of smart cutting tools in terms of the level of vibration amplitude, the roughness R_a of the processed surfaces respectively the values of cutting forces in comparison with the classic cutting tool.

8.2. Contributions in the field of theoretical and experimental research carried out within the research

The purpose of carrying out the research carried out in order to realize this doctoral thesis was to achieve the proposed objectives, both at the theoretical and at the practical level. Thus, starting from the premise that machining processes occupy a leading place in the machining industry, and especially that the turning machining process is the most used machining process, I considered it necessary to carry out this research based on analyzes theoretical and experimental, regarding the evolution of the geometry of the cutting tools during the turning process with longitudinal and transverse feed, in order to identify its influence on the dynamic phenomena (vibrations) that accompany the turning process, but also the analysis of the influence on the roughness of the processed surfaces and the forces that appear during the technological turning process.

In this sense, the main objective of the research was to find technical solutions that would allow the reduction of dynamic phenomena (vibrations), the improvement of the quality of the processed surfaces and the reduction of cutting forces in the context of a sustainable production respecting the three pillars: environment, social and economic.

Also, in the framework of the experimental research, steel semi-finished products were used, because this material is the most used in the machine building industry. Thus, we made the decision to use steel materials with different mechanical and technological properties, these categories of materials being extremely used in the machine building industry.

In order to achieve the proposed objectives, theoretical and experimental activities were undertaken, within which there were own theoretical and experimental contributions.

Own theoretical contributions:

✓ the analysis of specialized literature from the world level regarding the phenomenon the vibrations that occur during the machining processes by cutting; this analysis, carried out from the point of view of the factors that influence their level, of their effects on the results of the cutting processing processes and especially the analysis of the specialized literature regarding the methods and technical solutions applied to the cutting tools in order to eliminate/ mitigation of the dynamic phenomena (vibrations) faced by machining processes because it is known that vibrations are inevitable phenomena in the implementation of machining processes with negative effects on the results of machining processes.

Following the theoretical analysis of the specialized literature, Chapter 1 resulted, entitled "The current stage of vibration analysis in cutting processing processes", according to which the researchers focused on the identification of technical solutions applied to the cutting tool clamping system and constructive technical solutions applied to the body of the cutting tool in order to reduce/eliminate the vibrations that occur during the cutting process. They did not study solutions to reduce these phenomena by maintaining the optimal constant cutting tool geometry. Thus, the realization of technical solutions by mounting flexible elements under the cutting plate

that maintain the optimal functional geometry, not only does not introduce vibrations, but such solutions manage to reduce the level of vibrations, inevitably produced by the development of the machining process by cutting.

It should be mentioned that the designed geometry of the cutting tools refers to the constructive geometry, but during machining the constructive geometry becomes a functional one. Thus, the functional geometry of the tools is the one that greatly influences the machining process of the parts and implicitly the quality of the obtained parts. Currently, special attention is paid to the constructive geometry of the cutting tool, without taking into account the fact that the functional geometry of the tool also depends on the following parameters: cutting speed, feed speed and dimensions of the processed piece .

✓ thus, also at the theoretical level, the analysis of the variation of the functional geometry took place cutting tools when turning with transverse and longitudinal feed by identifying the influencing factors that determine this variation. Also, also within the framework of the theoretical research, there was an analysis of the influence of this variation on the roughness of the processed surfaces but also on the cutting forces. The analyzes carried out at the theoretical level demonstrate that there is a link between the variation of the functional geometry of the cutting tool, the quality of the processed surfaces represented by the roughness R_a (μm) and the forces that appear during machining.

✓ also , the mathematical modeling with the help of Hilbert spaces was carried out trajectories made by the tip of the cutting tool for classic tools and for the smart cutting tool variant (the category of tools that maintain constant geometry).

In order to achieve the proposed objectives, as part of the research, research at the application level was also carried out.

Own experimental contributions:

✓ and T03 , shown in Figure 2.3, were created by adding elastic elements under the cutting plate, the purpose of which is to maintain an optimal functional geometry in order to reduce the negative effects it produces on the results of the cutting process.

In this sense , the cutting tools presented in Figure 2.3 were used in the applied research, with the help of which 8 experiments were carried out with each cutting tool separately for each processed material, according to the experimental research plan established based on the principle of factorial experiments described in Chapter 2- "Materials, tools and methods used in experimental research".

✓ the analysis of the cutting tool was carried out from the point of view of a dynamic system with with the help of mathematical modeling, and with the help of the Matlab program, the real trajectories of the tip of the cutting tool were obtained, necessary for the generation of the surfaces obtained by turning with transverse and longitudinal feed .

✓ in the course of the turning operations provided for in the research plan experimentally, the vibrations that appear in the processing process were measured for all three cutting tools used to process the three materials under study along two main Z directions, respectively Y, according to figure 2.6.

Thus, two Monitran MTN/1100C accelerometers with a standard sensitivity of 100mV/g and a response frequency from 2Hz to 20KHz were used to measure the vibrations. They were connected to the system specially created for the acquisition of the data taken and processed during the research (acquisition board NI USB-9233). The NI USB-9233 data acquisition device provides a USB interface for four channels of 24-bit analog inputs with integrated signal

conditioning. This NI USB-9233 data acquisition system supports the connection of IEPE (Integrated Electronics Piezo-Electric) sensors. The NI USB-9233 data acquisition device uses a combination of digital and analog filtering to obtain the most accurate and noise-free signal possible. Filtering is based on the frequency range or bandwidth of the signal.

To acquire the signal from the two accelerometers, we used a specially made virtual instrument in the LabView program. The acquisition tool, shown in Figure 2.7, contains signal acquisition, plotting and signal saving modules in ASCII format for both channels used.

✓ at the same time, the vibration diagrams presented in Chapter 5, obtained with the help of the Matlab program following the processing of the acquired signals using the fast Fourier transform method (Fast Fourier Transform) - FFT, of the Spectrograms using the Short-Time Fourier-Transformation analysis method and the diagrams made using the method of vibration signal analysis.

✓ Activities were carried out to measure the roughness of the surfaces processed with the three cutting tools T01, T02 and T03 respectively. In this stage of applied research, a ST1 roughness meter supplied by Hoffmann Industrial Tools SRL, Bucharest, Romania, was used to measure the roughness of the turned surfaces.

Also, the processing of the obtained results was carried out using the statistical software MINITAB. At this stage, a series of curves were obtained in order to qualitatively analyze the obtained surfaces. The obtained curves are the following: Curved profile, Filtered profile, Abbott-Firestone curve.

✓ also within the framework of experimental research, a system used for measurement was created of the cutting forces presented in figure 2.9, and the experimental research also focused on the measurement of the components of the cutting forces. Thus, a piezocapacitive force sensor, model PCB 261A13 from PCB, was used to measure the forces, which allows the measurement of forces both in dynamic and quasi-static mode. The sensor has a capacitance of 70 pF. In the Z direction, it allows measuring a maximum force of 44.48 kN and in the X and Y directions a maximum force of 19.57 kN. Prior to measuring the forces in the turning process, the sensor was calibrated, by measuring some static forces in the range of values of the forces measured in the process. An Instron 5587 tensile-compression testing machine was used for calibration.

The electrical signal transmitted by the force sensor is received via a low-noise cable to the digital charge amplifier CMD 600, produced by HBM. The amplified signal is transmitted to the Quantum X MX840B acquisition system also from HBM.

The Catman software package of the acquisition system was used for the acquisition, processing and measurement of forces.

✓ the values of the experimental results obtained for the dependent variables, (amplitude vibrations, roughness respectively the components of the cutting forces) were processed with the help of the STATISTICA program through the method of multiple regression analysis in order to determine the degree of influence of the independent variables (a_p , f respectively V) on the dependent variables (vibration amplitude, roughness R_a components of the cutting force).

8.3. Future research directions

Machining processes were, are and will remain very important in terms of the production of components in the machine building industry as well as in other industries.

Always, the competitive market is based on a sustainable production, quality and price being the defining factors regarding the performance of the processing processes. These performances can only be achieved by optimizing the machining processes in order to achieve the objectives of a sustainable production. Due to the results obtained and presented in this thesis, it emerges that the research aims to improve the machining processes through the use of intelligent cutting tools. However, there is certainly a need for future research directions related to turning processing with transverse and longitudinal feed, so it is recommended that research continue focused on the following activities:

- ✓ research can be extended to other categories of both metallic and non-metallic materials
- ✓ also, the research can be extended to semi-finished products of different sizes manufactured from the researched materials S235, C45, respectively 42CrMo4 and not only, using various cutting regimes;
- ✓ the identification of new types of elastic elements to be tested on various cutting tools, by using semi-finished products from metallic and non-metallic materials with various cutting regimes both for turning with transverse feed and for turning with longitudinal feed;
- ✓ expanding research on the adopted solution and on other machining processes .

REFERENCE

1. Abbas, A.T.; Gupta, M.K.; Soliman, M.S.; et al. Sustainability assessment associated with surface roughness and power consumption characteristics in nanofluid MQL-assisted turning of AISI 1045 steel. *Int. J. Adv. Manuf. Technol.* **2019**, *105*, 1311–1327. <https://doi.org/10.1007/s00170-019-04325-6>.
2. Abu-Zahra, N.H.; Lange, J.H. Tool Chatter Monitoring in Turning Operations Using Wavelet Analysis of Ultrasound Waves. *Int. J. Adv. Manuf. Technol.* **2002**, *20*, 248–254.
3. Abainia, S.; Ouelaa, N. Predicting the dynamic behaviour of the turning tool vibrations using an experimental measurement, numerical simulation and analytical modelling for comparative study. *Int. J. Adv. Manuf. Technol.* **2021**, *115*, 2533–2552.
4. Abouelatta, O.B.; Madl, J. Surface roughness prediction based on cutting parameters and tool vibrations in turning operations. *J. Mater. Process. Technol.* **2001**, *118*, 269–277.
5. Aliustaoglu, C.; Ertunc, H.M.; Ocak, H. Tool wear condition monitoring using a sensor fusion model based on fuzzy inference system. *Mech. Syst. Signal Process.* **2009**, *23*, 539–546.
6. Ambhore, N.; et al. Tool condition monitoring system: A review. *Mater. Today Proc.* **2015**, *2*, 3419–3428.
7. An-Chen, L.; Chia-Shang, L.; Shiuh-Tarng, C. Analysis of Chatter Vibration in a Cutter-Workpiece System. *Int. J. Mach. Tools Manuf.* **1991**, *31*, 221–234. [https://doi.org/10.1016/0890-6955\(91\)90006-O](https://doi.org/10.1016/0890-6955(91)90006-O).
8. Arias-Montiel, M.; Silva-Navarro, G.; Antonio García, A. Active Vibration Control in a Rotor System by an Active Suspension with Linear Actuators. *J. Appl. Res. Technol.* **2014**, *12*, 898–907. [https://doi.org/10.1016/S1665-6423\(14\)70596-6](https://doi.org/10.1016/S1665-6423(14)70596-6).
9. Arnold, R.N. The Mechanism of Tool Vibration in the Cutting of Steel. *Proc. Inst. Mech. Eng.* **1946**, *154*, 261–284. https://doi.org/10.1243/PIME_PROC_1946_154_037_02.
10. Arora, J.S. Guide to structural optimization. *ASCE Man. Rep. Eng. Pract.* **1997**, *90*.
11. Astrom, K.J.; Wittenmark, B. *Computer Controlled Systems, Theory and Design*; Prentice Hall: 1984.
12. Beggan, C.; et al. Using acoustic emission to predict surface quality. *Int. J. Adv. Manuf. Technol.* **1999**, *15*, 737–742.
13. Boca, M. *Cercetări teoretice și experimentale privind eroarea de prelucrare cauzată de rigiditatea sistemului tehnologic la strunjire*; Politehniun: Iași, România, 2011; ISBN 978-973-621-347.
14. Box, G.E.P.; Wilson, K.B. On the experimental attainment of optimum conditions. *J. R. Stat. Soc. B.* **1951**, *13*, 1–45.
15. Boutros, T.; Liang, M. Detection and diagnosis of bearing and cutting tool faults using hidden Markov models. *Mech. Syst. Signal Process.* **2011**, *25*, 2102–2124.
16. Beju, L.D. *Bazele teoriei sistemelor*; Editura Universității "Lucian Blaga" din Sibiu: Sibiu, România, 2000.
17. Brindasu, P.D.; Beju, L.D.; Cofaru, N. Generalized approach to the design of boring heads. *Rev. Roum. Sci. Tech.* **2007**, *Mecanique Appliquee*, 33–36.
18. Chen, B.; Chen, X.; Li, B.; He, Z.; Cao, H.; Cai, G. Reliability estimation for cutting tools based on logistic regression model using vibration signals. *Mech. Syst. Signal Process.* **2011**, *25*, 2526–2537.
19. Cofaru, I.I.; Brîndașu, P.D.; Cofaru, N.F. Designing a Specialized Device for Correction of the Axis Deviation at the Human Leg. *Appl. Mech. Mater.* **2013**, *371*, 662–666.
20. Claesson, I.; Håkansson, L. Adaptive active control of machine-tool vibration in a lathe. *Int. J. Acoust. Vib.* **1998**, *3*, 4.
21. Chou, Y.K.; Song, H. Tool Nose Radius Effects on Finish Hard Turning. *J. Mater. Process. Technol.* **2004**, *148*, 259–268. <https://doi.org/10.1016/j.jmatprotec.2003.10.029>.
22. Dimla, D.E.; Lister, P.M. On-line metal cutting tool condition monitoring. I: force and vibration analyses. *Int. J. Mach. Tools Manuf.* **2000**, *40*, 739–768.

23. Dimla, D.E.S. The Correlation of Vibration Signal Features to Cutting Tool Wear in a Metal Turning Operation. *Int. J. Adv. Manuf. Technol.* **2002**, *19*, 705–713. <https://doi.org/10.1007/s001700200080>.
24. Doi, S.; Kato, S. Chatter vibration of lathe tools. *Trans. ASME* **1956**, *78*.
25. Dobrotă, D.; Racz, S.-G.; Oleksik, M.; Rotaru, I.; Tomescu, M.; Simion, C.M. Smart Cutting Tools Used in the Processing of Aluminum Alloys. *Sensors* **2022**, *22*, 28. <https://doi.org/10.3390/s22010028>,
26. Dobrotă, D.; Oleksik, M.; Chicea, A.L. Ecodesign of the Aluminum Bronze Cutting Process. *Materials* **2022**, *15*, 2735. <https://doi.org/10.3390/ma15082735>.
27. Dobrotă, D.; Tomescu, M. The analysis of the evolution of the functional geometry of the tool at the lathing with a transverse advance. *Fiabil. Durabil.* **2017**, *2*, 31–38.
28. Dobrotă, D.; Tomescu, M. Analysis of the evolution of the roughness of surfaces processed by turning depending on the functional geometry of the cutting tool. *Fiabil. Durabil.* **2018**, *1*, 144–148.
29. Dobrotă, D.; Tomescu, M. The influence of the functional geometry of the cutting tool on the main cutting force in the string operation. *Annals of the “Constantin Brancusi” University of Targu Jiu, Engineering* **2018**, *2*, 119–126.
30. Domnita, F. *Bazele fabricatiei*; Ed. Utpress: Cluj Napoca, Romania, 2019.
31. Dornfeld, D.; Pan, C. Determination of Chip Forming States Using Linear Discriminant Function Technique with Acoustic Emission. In Proceedings of the 13th North American Manufacturing Research Conference, Berkeley, CA, USA, 19–22 May 1985; pp. 299–303.
32. Elangovan, M.; Sugumaran, V.; Ramachandran, K.I.; Ravikumar, S. Effect of SVM kernel functions on classification of vibration signals of a single point cutting tool. *Expert Syst. Appl.* **2011**, *38*, 15202–15207.
33. Elliott, S.J. Active control using feedback. Technical Report 732, Institute of Sound & Vibration Research, University of Southampton, January 1994.
34. Gagnol, V.; Bouzgarrou, B.C.; Ray, P.; Barra, C. Model-based chatter stability prediction for high-speed spindles. *Int. J. Mach. Tools Manuf.* **2007**, *47*, 1176–1186.
35. Hanna, N.H.; Tobias, S.A. A theory of nonlinear regenerative chatter. *J. Eng. Ind.* **1974**, ASME.
36. Jangali, S.G.; Gaitonde, V.; Kulkarni, V.N.; Madhusudhana, H. Analyzing the effect of cutting parameters on forces and tool-tip temperature in turning of nickel-based superalloy using FE simulation. *Mater. Today Proc.* **2021**, *49*, 1833–1843.
37. Jiang, H.; Wang, C.; Ren, Z.; Yi, Y.; He, L.; Zhao, X. Influence of cutting velocity on gradient microstructure of machined surface during turning of high-strength alloy steel. *Mater. Sci. Eng. A* **2021**, *819*, 141354.
38. Jurkovic, J.; Korosec, M.; Kopac, J. New approach in tool wear measuring technique using CCD vision system. *Int. J. Mach. Tools Manuf.* **2005**, *45*, 1023–1030.
39. Kashyzadeh, K.R.; Ostad-Ahmad-Ghorabi, M.J. Study of chatter analysis in turning tool and control methods—a review. *Int. J. Emerg. Technol. Adv. Eng.* **2012**, *2*, 1–5.
40. Kilundu, B.; Dehombreux, P.; Chimentin, X. Tool wear monitoring by machine learning techniques and singular spectrum analysis. *Mech. Syst. Signal Process.* **2011**, *25*, 400–415.
41. Kolluru, K.; Axinte, D.; Becker, A. A solution for minimising vibrations in milling of thin-walled casings by applying dampers to workpiece surface. *CIRP Ann.* **2013**, *62*, 415–418. <https://doi.org/10.1016/j.cirp.2013.03.136>.
42. Kudinov, V.A. *Dinamica mașinilor-unelte*; Editura Tehnică: București, România, 1970.
43. Kuntoğlu, M.; Aslan, A.; Pimenov, D.Y.; Usca, Ü.A.; Salur, E.; Gupta, M.K.; Sharma, S. A review of indirect tool condition monitoring systems and decision-making methods in turning: Critical analysis and trends. *Sensors* **2020**, *21*, 108.
44. Kuntoğlu, M.; Aslan, A.; Pimenov, D.Y.; Giasin, K.; Mikolajczyk, T.; Sharma, S. Modeling of cutting parameters and tool geometry for multi-criteria optimization of surface roughness and vibration via response surface methodology in turning of AISI 5140 steel. *Materials* **2020**, *13*, 4242.

45. Kuntoğlu, M.; Saglam, H. Investigation of progressive tool wear for determining of optimized machining parameters in turning. *Measurement* **2019**, *140*, 427–436.
46. Kuntoğlu, M.; Saglam, H. Investigation of Signal Behaviors for Sensor Fusion with Tool Condition Monitoring System in Turning. *Measurement* **2020**, *108582*.
47. Kuo, S.M.; Morgan, D.R. *Active Noise Control Systems*; Telecommunications and Signal Processing, Wiley: 1996.
48. Liu, Y.; Liu, Z.; Song, Q.; Wang, B. Analysis and implementation of chatter frequency dependent constrained layer damping tool holder for stability improvement in turning process. *J. Mater. Process. Technol.* **2019**, *266*, 687–695.
49. Linus, P. *Vibrations in Metal Cutting Measurement, Analysis and Reduction*; Blekinge Institute of Technology: Ronneby, Sweden, 2002.
50. Laghari, R.A.; Li, J.; Mia, M. Effects of Turning Parameters and Parametric Optimization of the Cutting Forces in Machining SiCp/Al 45 wt% Composite. *Metals* **2020**, *10*, 840. <https://doi.org/10.3390/met10060840>.
51. Li, X. A brief review: acoustic emission method for tool wear monitoring during turning. *Int. J. Mach. Tools Manuf.* **2002**, *42*, 157–165.
52. Luthra, H.S. Influence of the dynamic and machining parameters in dynamic characteristics of a turning process and prediction of chatter, PhD Thesis, Katholieke University Leuven, 1974.
53. Lu, X.; Chen, F.; Altintas, Y. Magnetic actuator for active damping of boring bars. *CIRP Ann.* **2014**, *63*, 369–372.
54. Ma, H.; Wu, J.; Yang, L.; Xiong, Z. Active chatter suppression with displacement-only measurement in turning process. *J. Sound Vib.* **2017**, *401*, 255–267.
55. Manhertza, G.; Akos Bereczkyb, A. STFT spectrogram based hybrid evaluation method for rotating machine transient vibration analysis. *Mech. Syst. Signal Process.* **2021**, *154*, 107583. <https://doi.org/10.1016/j.ymsp.2020.107583>.
56. Martins da Silva, M.; Sardi, V.G.; Sérgio, V.P.; Teixeira, C.R. Experimental results on chatter reduction in turning through embedded piezoelectric material and passive shunt circuits. *Mechatronics* **2015**, *29*, 78–85.
57. Mei, D.; Kong, T.; Shih, A.J.; Chen, Z. Magnetorheological fluid-controlled boring bar for chatter suppression. *J. Mater. Process. Technol.* **2009**, *209*, 1861–1870.
58. Meritt, H.E. Theory of self-excited machine-tool chatter. *Trans. ASME* **1965**, *87*, 447–454.
59. Mia, M.; Dey, P.R.; Hossain, M.S.; Arafat, M.T.; Asaduzzaman, M.; Ullah, M.S.; Zobaer, S.T. Taguchi S/N based optimization of machining parameters for surface roughness, tool wear and material removal rate in hard turning under MQL cutting condition. *Measurement* **2018**, *122*, 380–391.
60. Mei, D.; Yao, Z.; Kong, T.; Chen, Z. Parameter optimization of time-varying stiffness method for chatter suppression based on magnetorheological fluid-controlled boring bar. *Int. J. Adv. Manuf. Technol.* **2010**, *46*, 1071–1083.
61. Moraru, V.; Ispas, C.; Rusu, Șt. *Vibrațiile și stabilitatea mașinilor-unelte*; Editura Tehnică: București, România, 1982.
62. Muhammad Rizal, J.; Ghania, J.A.; Nuawi, M.Z.; Haron, C.H.C. The application of I-kaz™-based method for tool wear monitoring using cutting force signal. *Procedia Eng.* **2013**, *68*, 461–468.
63. Nelson, P.A.; Elliott, S.J. *Active Control of Sound*; Academic Press: San Diego, CA, USA, 1992.
64. Niancong, L.; Baolin, L.; Hao, J.; Shenghong, W.; Chengwen, Y.; Yun, C. Study on vibration and surface roughness in MQCL turning of stainless steel. *J. Manuf. Process.* **2021**, *65*, 343–353. <https://doi.org/10.1016/j.jmapro.2021.03.041>.
65. O'Donnell, G.; Young, P.; Kelly, K.; Byrne, G. Toward the improvement of tool condition monitoring system in manufacturing environment. *J. Mater. Process. Technol.* **2001**, *119*, 133–139.
66. Oleksik, M.; Dobrotă, D.; Tomescu, M.; Petrescu, V. Improving the Performance of Steel Machining Processes through Cutting by Vibration Control. *Materials* **2021**, *14*, 5712. <https://doi.org/10.3390/ma14195712>.

67. Oniță, G.V.; Brîndașu, P.D.; Beju, L.D. Aspects regarding product lifecycle management of cutting tools. *Proc. Manuf. Syst.* **2010**, *5*, 3.
68. Özel, T.; Karpat, Y.; Figueira, L.; Davim, J.P. Modelling of surface finish and tool flank wear in turning of AISI D2 steel with ceramic wiper inserts. *J. Mater. Process. Technol.* **2007**, *189*, 192–198.
69. Özel, T.; Karpat, Y. Predictive modeling of surface roughness and tool wear in hard turning using regression and neural networks. *Int. J. Mach. Tools Manuf.* **2005**, *45*, 467–479.
70. Ozlu, E.; Budak, E. Analytical modeling of chatter stability in turning and boring operations—Part I: Model development. *J. Manuf. Sci. Eng.* **2007**, *129*, 726–732.
71. Ozlu, E.; Budak, E. Analytical modeling of chatter stability in turning and boring operations—Part II: Experimental verification. *J. Manuf. Sci. Eng.* **2007**, *129*, 733–739.
72. Panda, A.; Olejárová, Š.; Valíček, J.; et al. Monitoring of the condition of turning machine bearing housing through vibrations. *Int. J. Adv. Manuf. Technol.* **2018**, *97*, 401–411. <https://doi.org/10.1007/s00170-018-1871-7>.
73. Petrusse, R.E.; Brîndașu, P.D. Augmented reality applied in machining processes and cutting tools management. *Appl. Mech. Mater.* **2014**, *693*, 279–284.
74. Péters, J.; Vanherck, P. Un critère de stabilité dynamique pour machine-outils. *CRIF* **1962**.
75. Quintana, G.; Ciurana, J. Chatter in machining processes: A review. *Int. J. Mach. Tools Manuf.* **2011**, *51*, 363–376.
76. Rao, K.V.; Murthy, B.S.N.; Rao, N.M. Cutting tool condition monitoring by analyzing surface roughness, work piece vibration and volume of metal removed for AISI 1040 steel in boring. *Measurement* **2013**, *46*, 4075–4084.
77. Rashid, A.; Nicolescu, C.M. Design and implementation of tuned viscoelastic dampers for vibration control in milling. *Int. J. Mach. Tools Manuf.* **2008**, *48*, 1036–1053. <https://doi.org/10.1016/j.ijmachtools.2007.12.013>.
78. Radharamanan, R. The measurement of the dynamic cutting coefficients and the analysis of chatter behaviour in turning, PhD Thesis, Katholieke University Leuven, 1977.
79. Rankine, L.; Mesbah, M.; Boashash, B. IF estimation for multicomponent signals using image processing techniques in the time–frequency domain. *Signal Process.* **2007**, *87*, 1234–1250.
80. Rao, K.V.; Murthy, B.S.N.; Rao, N.M. Cutting tool condition monitoring by analyzing surface roughness, work piece vibration and volume of metal removed for AISI 1040 steel in boring. *Measurement* **2013**, *46*, 4075–4084.
81. Ratnam, M. Factors Affecting Surface Roughness in Finish Turning. *Elsevier* **2017**, *3*, 1–25.
82. Rodean, C.; Beju, L.D.; Brîndașu, P.D. Systemic analysis of the caulking assembly process. In *MATEC Web of Conferences* **2017**, *121*, 03019.
83. Salgado, D.R.; Alonso, F.J.; Cambero, I.; Marcelo, A. In-process surface roughness prediction system using cutting vibrations in turning. *Int. J. Adv. Manuf. Technol.* **2009**, *43*, 40–51.
84. Satishkumar, S.; Asokan, P.; Kumanan, S. Optimization of depth of cut in multipass turning using nontraditional optimization techniques. *Int. J. Adv. Manuf. Technol.* **2006**, *29*, 230–238.
85. Shalaby, M.A.; El Hakim, M.A.; Veldhuis, S.C.; et al. An investigation into the behavior of the cutting forces in precision turning. *Int. J. Adv. Manuf. Technol.* **2017**, *90*, 1605–1615. <https://doi.org/10.1007/s00170-016-9465-8>.
86. Som, A.; Kim, D.-H.; Son, H. Semiactive Magnetorheological Damper for High Aspect Ratio Boring Process. *IEEE/ASME Trans. Mechatron.* **2015**, *20*, 5.
87. Siddhpura, M.; Paurobally, R. Experimental investigation of chatter vibrations in facing and turning processes. *Int. J. Mech. Mechatron. Eng.* **2013**, *7*, 968–973.
88. Siddhpura, M.; Paurobally, R. A review of chatter vibration research in turning. *Int. J. Mach. Tools Manuf.* **2012**, *61*, 27–47. <https://doi.org/10.1016/j.ijmachtools.2012.05.007>.
89. Siddhpura, M.; Paurobally, R. Review of flank wear prediction methods for tool condition monitoring in a turning process. *Int. J. Adv. Manuf. Technol.* **2013**, *65*, 371–393.

90. Sturesson, P.-O.; Håkansson, L.; Claesson, I. Identification of the statistical properties of the cutting tool vibration in a continuous turning operation: correlation to structural properties. *J. Mech. Syst. Signal Process.* **1997**, *11*, 3.
91. Sun, Y.; Yan, S. Dynamics Identification and Stability Analysis in Turning of Slender Workpieces with Flexible Boundary Constraints. *Mech. Syst. Signal Process.* **2022**, *177*, 109245. <https://doi.org/10.1016/j.ymsp.2022.109245>.
92. Sun, Y.; Yan, S. Enhancing Tool Dynamics and Stability in Internal Turning with an Adjustable Clamping Device under Variable Cutting Conditions. *Mech. Syst. Signal Process.* **2024**, *208*, 111007. <https://doi.org/10.1016/j.ymsp.2023.111007>.
93. Sun, J.; Hong, G.S.; Rahman, M.; Wong, Y.S. Identification of feature set for effective tool condition monitoring by acoustic emission sensing. *Int. J. Prod. Res.* **2004**, *42*, 901–918.
94. Sun, J.; Hong, G.S.; Rahman, M.; Wong, Y.S. Effective training data selection in tool condition monitoring system. *Int. J. Mach. Tools Manuf.* **2006**, *46*, 218–224.
95. Taylor, F. On the Art of Cutting Metals; The American Society of Mechanical Engineers: New York, NY, USA, 1907.
96. Taylor, F. On the art of cutting metals. *Trans. ASME* **1907**, *28*.
97. Tatar, K.; Gren, P. Measurement of milling tool vibrations during cutting using laser vibrometry. *Int. J. Mach. Tools Manuf.* **2008**, *48*, 380–387.
98. Teti, R.; Jemielniak, K.; O'Donnell, G.; Dornfeld, D. Advanced monitoring of machining operations. *CIRP Ann. Manuf. Technol.* **2010**, *79*, 717–739.
99. Tewani, S.G.; Rouch, K.E.; Walcott, B.L. A study of cutting process stability of a boring bar with active dynamic absorber. *Int. J. Mach. Tools Manuf.* **1995**, *35*, 91–108.
100. Tobias, S.A.; Fishwick, W. The chatter of lathe tools under orthogonal cutting conditions. *Trans. ASME* **1958**, *80*, 1079–1088.
101. Tobias, S.A. *Machine Tool Vibration*; Blackie and Sons Ltd.: Glasgow, UK, 1965.
102. Tlustý, J.; Polacek, M. The stability of machine tools against self-excited vibrations in machining. In *Proceedings of the International Research in Production Engineering Conference*, Pittsburgh, PA, USA, 9–12 September 1963; ASME: New York, NY, USA, 1963; pp. 465–474.
103. Tlustý, J.; Polacek, M. The stability of machine tools against self-excited vibrations in machining. *Proc. Int. Res. Prod. Eng. Conf.* **1963**, *465*, 474.
104. Tlustý, J. *Manufacturing Process and Equipment*; Prentice-Hall: New York, NY, USA, 2001.
105. The Ho, Q.N.; Do, T.T.; Minh, P.S. Studying the Factors Affecting Tool Vibration and Surface Quality during Turning through 3D Cutting Simulation and Machine Learning Model. *Micromachines* **2023**, *14*, 1025. <https://doi.org/10.3390/mi14051025>.
106. Tomas, Ö. Investigation of Vibrations During Internal Turning: An Experimental and Numerical Study. Department of Industrial Production, KTH, Stockholm Measurements: LEAX Group, Falun.
107. Tomescu, M.; Ionescu, C. Analysis of the evolution of the durability of cutting tools depending of functional geometry. *Fiabil. Durabil.* **2019**, *1*, 164–168.
108. Tomescu, M. Analysis of the possibilities of reduction and measurement of cutting tool vibrations during the cutting process. *Annals of “Constantin Brancusi” University of Targu-Jiu. Engineering* **2020**, *2*, 205–210.
109. Tomescu, M.; Ionescu, C. Analysis of the factors that influence the processing precision and the effects of the vibrations from the cutting process on it. *Annals of “Constantin Brancusi” University of Targu-Jiu. Engineering* **2020**, *2*, 195–204.
110. Tomescu, M.; Ionescu, C. Analysis of the variation of the cutting tool wear due to the modification of the functional geometry of the tool cutter during processing. *Annals of “Constantin Brancusi” University of Targu-Jiu. Engineering* **2021**, *4*, 48–59.
111. Tomescu, M.; Ionescu, C. Analysis of the influence of the seating angle " α " on the vibrations that appear during turning processing. *Annals of “Constantin Brancusi” University of Targu-Jiu. Engineering* **2022**, *4*, 115–123.

112. **Tomescu, M.**; Ionescu, C. Analysis of the influence of the variation of the functional geometry of the cutting tool on the cutting force during turning with transverse feed. *Fiabil. Durabil.* **2024**, *1*, 78–85.
113. **Tomescu, M.**; Oleksik, M. Analysis of the variation of vibration amplitude when working with intelligent shearing tools. *Annals of “Constantin Brancusi” University of Targu-Jiu. Engineering* **2023**, *4*, 43–52.
114. **Tomescu, M.**; Oleksik, M. Performance analysis of the use of cutting tools with optimal functional geometry from the point of view of the quality of the surfaces processed by cutting. *Annals of “Constantin Brancusi” University of Targu-Jiu. Engineering* **2023**, *4*, 53–63.
115. **Tomescu, M.**; Rotaru, I.M. Analysis of the variation of the roughness obtained during turning with transverse feed due to the modification of the functional geometry of the cutting tool. *Fiabil. Durabil.* **2023**, *1*, 37–44.
116. **Tomescu, M.**; Rotaru, I.M. Analysis of the variation of vibrations that appear during turning works with transverse feed due to the modification of the functional geometry of the cutting tool. *Fiabil. Durabil.* **2023**, *1*, 45–52.
117. **Tomescu, M.** Performance Analysis of the Use of Cutting Tools with Functional Geometry in the Processing of Aluminum Alloys used in the Aerospace Industry. Presented at 2024 5th International Conference on Mechanical and Aerospace Systems (ICMAS 2024), held at The British University in Cairo, Egypt during April 22-24, **2024**.
118. Turkes, E.; Orak, S.; Neseli, S.; Yaldiz, S. Linear analysis of chatter vibration and stability for orthogonal cutting in turning. *Int. J. Refract. Met. Hard Mater.* **2011**, *29*, 163–169.
119. Urbikain, G.; Olvera, D.; López de Lacalle, L.N.; Beranoagirre, A.; Elías-Zuñiga, A. Prediction methods and experimental techniques for chatter avoidance in turning systems: A review. *Appl. Sci.* **2019**, *9*, 4718.
120. Ullah, A.; Chan, T.-C. Improving CNC Turning Machine Precision through Vibration Analysis for Clamping Error Detection Employing Principal Component Analysis. *Research Square* **2024**. <https://doi.org/10.21203/rs.3.rs-4010726/v1>.
121. Vlase, A.; Sturzu, A.; Mihail, A.; Bercea, I. *Regimuri de aşchiere, adaosuri de prelucrare și norme tehnice de timp*; Editura Tehnică: București, România.
122. Wang, G.F.; Yang, Y.W.; Zhang, Y.C.; Xie, Q.L. Vibration sensor-based tool condition monitoring using support vector machine and locality preserving projection. *Sensors Actuators A Phys.* **2014**, *209*, 24–32.
123. Wang, A.; Jin, W.; Chen, W.; Feng, R.; Xu, C. Bifurcation and chaotic vibration of frictional chatter in turning process. *Adv. Mech. Eng.* **2018**, *10*, 4.
124. Wiercigroch, M.; Budak, E. Sources of Nonlinearities, Chatter Generation and Suppression in Metal Cutting. *Philos. Trans. R. Soc. A Math. Phys. Eng. Sci.* **2001**, *359*, 663–693.
125. Xianguo, H.; Huajiang, O.; Minjie, W.; Nurhafizzah, H.; Yuming, M. Self-excited vibration of workpieces in a turning process. *Proc. Inst. Mech. Eng. Part C: J. Mech. Eng. Sci.* **2012**, *226*, 1958–1970.
126. Wang, Y.; Tse, P.W.; Tang, B.; Qin, Y.; Deng, L.; Huang, T.; Xu, G. Order spectrogram visualization for rolling bearing fault detection under speed variation conditions. *Mech. Syst. Signal. Process.* **2019**, *122*, 580–596.
127. Wang, A.; Jin, W.; Chen, W.; Feng, R.; Xu, C. Bifurcation and chaotic vibration of frictional chatter in turning process. *Adv. Mech. Eng.* **2011**, *10*, 4.
128. Wiercigroch, M.; Budak, E. Sources of Nonlinearities, Chatter Generation and Suppression in Metal Cutting. *Philos. Trans. R. Soc. A Math. Phys. Eng. Sci.* **2001**, *359*, 663–693.
129. Xianguo, H.; Huajiang, O.; Minjie, W.; Nurhafizzah, H.; Yuming, M. Self-excited vibration of workpieces in a turning process. *Proc. IMechE Part C: J. Mech. Eng. Sci.* **2012**, *226*, 1958–1970.
130. Yadav, R.N. A hybrid approach of Taguchi-Response surface methodology for modeling and optimization of duplex turning process. *Measurement* **2017**, *100*, 131–138.
131. Yan, S.; Qi, S.; Sun, Y. Cutting Conditions Dependent Adjustment of Dynamic Responses for Slender Tools in Internal Turning with a Flexible Vibration Suppression Device. *J. Manuf. Process.* **2024**, *113*, 76–94. <https://doi.org/10.1016/j.jmapro.2024.01.053>.

132. Yigit, U.; Cigeroglu, E.; Budak, E. Chatter reduction in boring process by using piezoelectric shunt damping with experimental verification. *Mech. Syst. Signal Process.* **2017**, *97*, 312–321.
133. Yue, C.; Gao, H.; Liu, X.; Liang, S.Y.; Wang, L. A review of chatter vibration research in milling. *Chin. J. Aeronaut.* **2019**, *32*, 215–242.
134. Yang, C.; Ouyang, H. A novel load-dependent sensor placement method for model updating based on time-dependent reliability optimization considering multi-source uncertainties. *Mech. Syst. Signal Process.* **2022**, *165*, 108386.
135. Yemul, N.N.; Deshpande, G.R. Literature Review on Tool Wear in Turning Operation of Aluminium. *Int. J. Innov. Eng. Res. Technol.* **2021**, *8*, 15–17.
136. Yue, C.; Gao, H.; Liu, X.; Liang, S.Y.; Wang, L. A review of chatter vibration research in milling. *Chin. J. Aeronaut.* **2019**, *32*, 215–242.
137. Zagórski, I.; Korpysa, J.; Weremczuk, A. Influence of Tool Holder Types on Vibration in Rough Milling of AZ91D Magnesium Alloy. *Materials* **2021**, *14*, 2517.
138. Zagórski, I.; Kulisz, M.; Kłonica, M.; Matuszak, J. Trochoidal milling and neural networks simulation of magnesium alloys. *Materials* **2019**, *12*, 2070.
139. Zhu, B.; Zhao, Y.; Xiong, L.; Zhang, C.; Zhang, W.; Chen, X. Finite Element Investigations for Chip Scraping During Orthogonal Cutting Process with Micro-Textured Tools. *J. Manuf. Process.* **2024**, *120*, 493–505. <https://doi.org/10.1016/j.jmapro.2024.04.060>.
140. <https://cuttingtools.ceratizit.com/ro/ro/cunostinte-de-aschiere/prelucrare-prin-strunjire/consiliere/alegere-placute-amovibile.html> Alegerea plăcuței amovibile corecte - ce trebuie avut în vedere? (ceratizit.com)
141. https://dspace.upt.ro/jspui/bitstream/123456789/4800/1/BUPT_TD_Crivacucea%20Codruta-Oana.pdfBUPT_TD_Crivacucea Codruta-Oana.pdf
142. <https://sim.tuiasi.ro/wp-content/uploads/Gh.Badarau-Proprietatile-materialelor-metalice.pdf>Gh.Badarau-Proprietatile-materialelor-metalice.pdf (tuiasi.ro)
143. <https://ro.scribd.com/document/639087052/Poster-Surface-Roughness-Parameters-en-10037103roughness-measurement-poster-en.pdf>
144. https://www.hoffmanngroup.com/RO/ro/horo/v2/search?page=&sort=&tId=786&search=iscar&gclid=Cj0KCQjwo8S3BhDeARIsAFRmkOP5qcz5oAut_c4qB4gOTVf2DzuGf6DW7Mn8H2Z0F2C_NtzsxdvduSoUaAi6AEALw_wcBScule Așchietoare Antivibratoare TTonline
145. <https://ro.scribd.com/document/533450390/Simbolizare-materiale-1Simbolizare> Materiale | PDF (scribd.com)
146. https://www.unitbv.ro/documente/cercetare/doctorat-postdoctorat/sustinere-teza/2023/andrei-ionut-berariu/TEZA_DOCTORAT_REZUMAT_Ing_BERARIU_Andrei.pdf TEZA_DOCTORAT_REZUMAT_Ing_BERARIU_Andrei.pdf (unitbv.ro)
147. https://www.secotools.com/article/1_20669?language=ro
148. http://www.revtn.ro/pdf1-2018/8_SZAKACS_template-ntr-word-2007_2011.pdf(Internet from 21-Jan-2019)
149. <https://pdfcoffee.com/calcul-forta-aschiere-pdf-free.htm>
150. Measuring Vibration: The Complete Guide. Available online: <https://www.bksv.com/en/knowledge/blog/vibration/measuring-vibrationN/> (accessed on 5 May 2021).
151. https://docs.upb.ro/wp-content/uploads/2022/09/REZUMAT-TEZA_Vladulescu_RO.pdf